



AN
UNLIMITED
PROMOTIONAL
WORLD



NEED
M

REF. PG.

6998	292
6999	337
7000	314, 356
7008	359
7009	358
7012	359
7013	318
7014	317
7015	318
7018	318
7019	359
7020	314, 354
7023	355
7024	358
7026	354
7030	357
7033	355
7041	358
7043	326
7044	327
7045	329
7046	325
7047	325
7048	314, 353
7049	313, 330
7050	314, 356
7052	328
7053	328
7054	327
7055	328
7057	314, 352
7060	318
7061	319
7062	319
7063	319
7068	329
7069	329
7070	329
7071	313, 331
7081	248
7082	248
7083	123
7084	155
7085	152
7086	162
7087	152
7088	160, 343
7089	161, 343
7090	154
7091	153
7092	349
7093	346
7094	346
7095	345
7096	336
7097	347
7098	152
7099	177
7100	336
7101	352
7102	348
7103	314, 352
7104	315, 353
7105	315, 351
7106	125
7107	153, 170
7110	176
7114	157, 302

7115	146
7118	351
7119	314, 352
7120	146
7121	147
7122	182
7123	182
7124	150
7125	188
7126	190
7127	190, 303
7128	187
7137	154
7138	130
7139	124
7145	150
7146	129
7147	184
7148	178
7149	178
7150	156
7151	158
7152	156, 302
7153	149
7154	149, 302
7155	157
7156	169
7157	156
7158	151
7159	168
7160	173
7161	177, 342
7162	170
7163	179
7164	179
7165	153
7166	187
7167	168
7168	168
7169	280
7170	145
7171	128
7172	127
7173	129
7174	151
7175	154
7176	125
7177	126
7178	122
7179	145
7180	155, 191, 301
7181	149
7182	147, 371
7183	148
7184	155
7185	176
7186	119
7187	120
7188	171
7189	171
7190	167
7191	167
7193	169
7194	166
7195	166
7196	173
7197	160, 342
7198	144

7497	138, 372
7498	139, 372
7499	374
7500	124
7501	189
7502	189
7503	188
7504	189
7506	190
7511	143, 371
7513	143, 375
7514	143, 375
7515	130
7516	131
7517	131
7518	131
7519	174
7520	172
7521	173
7522	186, 303
7523	186
7525	174
7526	158
7527	190, 303
7528	158
7529	159, 259
7530	159, 259
7531	341
7532	341
7533	341
7534	185
7535	185
7536	139
7537	141, 372
7538	183
7539	183
7540	183
7541	183
7542	115, 137
7543	184
7544	137
7545	137
7546	115
7547	142, 374
7548	136
7549	185, 303
7550	157, 302
7551	172
7552	175
7553	174
7554	175
7555	179
7556	177
7557	154
7558	141, 373
7559	115
7560	140
7561	182
7562	139
7563	140, 373
7564	140, 373
7565	143, 375
7566	124
7567	126
7568	126
7569	142, 191, 301
7570	137, 364
7571	97, 159, 259

7573	136
7599	138, 165
7600	164
7601	172
7602	173
7603	163, 342
7604	163, 343
7605	162
7606	164
7607	164
7608	161, 207
7609	161, 207
7610	180
7611	181
7612	181
7613	180
7614	175
7615	175
7616	145
7617	170
7618	191, 301
7971	104
7972	91
7973	90
7974	105
7975	91
7976	92
7977	103
7978	103
7979	105
7980	102
7981	93
7982	76
7983	77
7984	101
7985	100
7986	74
7987	108
7988	107
7989	98
7990	76
7991	72
7992	72
7993	71
7994	110
7995	91
7996	99
7997	99
7998	93
7999	93
8000	98
8001	99
8002	95
8003	95, 273
8004	87
8005	87
8006	85
8008	82
8009	78
8010	80
8011	85
8012	85
8013	88
8014	87
8015	89, 377
8017	77
8018	74
8019	74

8020	117
8021	77
8022	79, 376
8023	94, 275
8024	94
8025	78
8028	78
8029	83
8030	88
8031	78
8032	82
8033	84
8034	75
8035	80
8036	73
8038	79, 377
8039	79, 377
8040	80, 377
8041	73
8042	83
8043	83
8044	72
8045	80
8046	95, 376
8047	258
8048	84
8049	96, 258
8050	109
8051	109
8052	111
8053	112
8054	111
8055	112
8056	114
8057	114
8059	116
8060	109, 376
8061	109, 376
8062	114
8063	113
8064	97
8065	116
8066	116
8067	116, 258
8068	116
8069	96, 258
8070	110
8071	107
8072	107
8073	110
8074	111
8076	78
8077	96
8078	88
8079	83
8080	75
8081	106
8082	106
8083	116
8084	75
8085	113
8086	113
8087	97
8088	95, 273
8089	99
8090	89
8091	108
8092	98

8093	73, 88
8094	86, 272
8095	87
8096	81
8098	86
8099	81
8100	335
8101	335
8102	334
8103	335
8104	334
8105	333
8110	303, 334
8150	337
8151	133, 370
8199	133, 370
8200	133, 370
8201	133, 370
8202	340
8204	135
8205	340
8206	135
8311	134
9001	315, 353
9003	320
9004	293
9009	292
9128	242
9129	242, 315
9130	242
9131	159, 259
9132	243
9133	242
9134	243, 315
9135	241
9136	240
9137	243
9138	241
9139	239
9140	239
9141	240
9142	240
9143	240
9144	241
9322	350
9906	368
9907	368
9908	368
9919	368
9921	273
9923	366
9924	367
9934	368
9935	135, 371
9939	371
9944	367
9945	366
9946	367
9947	293

INDEX BY PRODUCT / FAMILY

A	
Air freshener	280
Antibacterial notepads	109, 376
Antibacterial pens	79, 89, 377
Anti-theft backpack	127
Aprons	239, 240, 241, 242, 315
Aroma diffuser	262
Apron for colouring	259, 159
B	
Backpack bags	170
Backpacks	302, 123, 124, 125, 125, 126, 127, 128, 129, 130, 145, 146, 147, 148, 149, 150, 151
Backpacks for sublimation	301, 302, 155, 191
Badge holders	329
Bags	301, 303, 166, 167, 168, 169, 170, 171, 172, 173, 174, 175, 176, 177, 178, 179, 180, 181, 182, 183, 184, 185, 187, 188, 189
Bags for Sublimation	301, 303, 190, 191
Ball	287, 350
Ball pens	72, 73, 74, 75, 76, 78, 79, 80, 81, 82, 83, 84, 85, 86, 87, 88, 89, 90, 91, 94
Beach rackets	338
Beach umbrella	337
Belt pouch	136
Blankets	289, 290, 291
Bottle cooler	248
Bottles	211, 213, 214, 215, 216, 217, 219, 220, 221, 222, 223, 224, 225, 228, 229, 230, 231, 232, 233, 234, 235, 236, 237, 304, 305, 306
Bottles for sublimation	223, 228, 304, 305
Bracelets	313, 324, 331
Brush with mirror	363
Bucket	339
Backpack for colouring	259, 159
Bag for Colouring	259, 159
C	
Calendars	116
Candles	262, 263
Caps	314, 354, 355, 356, 357, 358, 359
Car truck organizer	280
Carpenter's pencil	95, 273
Cases	97, 115
Charger desk tray	31
Charger holder	32, 37
Charger mat	19, 40
Chargers 3 in 1	29, 59
Charging Watch	22, 23
Cheese set	246
chopping board	245
Christmas decorations	136, 137

Christmas decorations set	137
Christmas hat	138
Christmas pencils	139
Christmas socks	138
Clappers	305, 321
Coaster	247
Cocktail shaker	253
Cocktails set	252
Colour pencils	99
Comb	362, 364
Cooler backpack	343, 160, 161, 163
Cooler bags	342, 160, 177, 207, 342, 161, 162, 163, 164
Colour crayons	98
Corkscrew	249
Cotton backpacks	145, 152, 153, 154, 155
Cotton bags	166, 168, 169, 170, 171, 172, 173, 174, 175
Cup	193, 200, 201, 208, 209, 210, 213, 227, 236, 306, 325
Cup for sublimation	193, 306
Cutlery set	204, 205
Cutters	272
Case for colouring	259, 159
D	
Deck of cards	255
Diaries	116
Digital kitchen scale	244
Document bags	124, 130, 131
Drawing set	96, 98, 258
Drawstring backpack	302, 152, 153, 156, 157, 158, 159
Drinking Glass	193, 200, 201, 208, 209, 210, 213, 227, 236, 306, 325
E	
Earphones	16, 25, 28, 39, 42, 43, 50, 51, 52, 53, 54
Earplugs	370, 133
Elastic bands set	347
Endless pen	92, 93
F	
Fairtrade backpack	152
Fairtrade bags	166
Fairtrade toilet bag	138, 139
Fans	322, 323
Flags	321
Flashlights	275
Fleece neckwarmer	293
Flexometer	274
Flip flops	337
Flower pot	260, 261
Foldable bags	176, 186

Foldable bowl	287
Foldable umbrellas	298, 299, 311
Frisbee	287, 338
G	
Glass bottles	Glass bottles
Glasses pouches	Glasses pouches
H	
Ham cover	187
Hat	292, 337, 317, 318, 319
Hat bands	302
Hemp backpack	154
Hemp bags	167
Hemp toilet bag	138
high-visibility wristband	351
Hip flask	253
Hydroalcoholic gels	368
I	
Ice Scraper	281
Inflatable ball	338
Insulated bottles	211, 219, 220, 222, 223
J	
Jumping rope	346
Jute bags	176, 177, 178, 179, 180, 181
K	
Keyring flexometer	268
Keyrings	265, 266, 267, 268, 326
Kitchen cutting board	245
Kitchen mitts	241, 243
Kitchenware set	204, 205
Knit beanie	292, 337
Kitchen towel	240
L	
Lamp Alarm clock	13
Lanyards	313, 325, 326, 327, 328, 330
Laptop pouch	126
Lip balms	365
Luggage tag	135
Lunch boxes	201, 203, 204, 206
M	
Magnetic board	258
Manicure kit with	361, 134
Marker pens	84
Mask holder	371
Measuring cup	253
Mini notebooks	111

Mirrors	363
Mouse pad	19, 62, 63, 312
Mugs	194, 195, 196, 197, 198, 199, 200, 201, 202, 203, 208, 306, 307, 308, 309, 379
Mugs for sublimation	194, 195, 202, 306, 307, 308, 309
Multicolour backpack	155
Multicolour pen	86
Multipurpose bag	144, 145, 173
Multipurpose dry bag	340
Multipurpose folder	100, 101, 102
Multipurpose thermo	226
Multi-Tool Ball pen	94, 272
Multitools	271, 272, 278
Multifunctional belt	351
N	
Neckwarmer hat	293
Notebooks	106, 110, 111, 112
Notepad holder	103
Notepads	103, 104, 105, 106, 107, 108, 109, 110
O	
Opener	249, 251, 267
Organizer	31
P	
Paper bags	182, 183
Pen pouch	91
Pencil case	97, 115
Pencil holder	18, 45
Pencils	95, 273, 376
Perpetual calendars	117
Personal Alarm	371, 132
pet collars	286
Photo frame charger	18, 22
Pill boxes	369
Plug adaptors	60, 132
pocket Ashtray	340
Pointer ball pens	74, 85, 86, 87, 89
Power banks	29, 30, 38, 56, 57
Purses	364, 137
Puzzle	257
R	
Recycling bags set	184
Roller and mechanical pencil	71
Roller pens	72, 77
RPET bags	185
Reversible hat	292
S	
Safety glasses	273

Sandwich holder	165
sanitizing wipe	368
Sarong towel	336
Scale	274
Scarves	320
Seed paper notebook	113
Seed paper notepad	113
Set of games	254
Shoe bag	371, 147
Shoe cleaning kit	134
Skill games	254, 256, 257
skittles set	254
Slippers	370, 133
Smart Watches	55
Smartphone holder	33, 44, 60, 61, 264
Solar power bank	56
Spatula	244
Speaker Charger	37, 41, 42, 47
Spoon	244
Sport Bands	347
Sports camera	56
Sports pinnie	320, 350
Spray pen	79, 376
Sticky notes pad	113, 114
Straws	205
Stress relievers	269, 369
Sublimation braçlets	313, 331
Sublimation Jar	193, 306, 308
Sublimation Kitchen mitts	243, 315
Sublimation Lanyards	313, 330
Sublimation toilet bags	301, 191
Sunglasses	333, 334, 335
Sunshield	283, 284, 285
T	
Table Lamp	14, 20, 26
Table mat	240
Tangram puzzle	257
Thermal blanket	282
Thermo cup	227
Thermos	212, 213, 224, 226, 305
Thick chalk set	98
Thread counting magnifier	273
Toilet bags	301, 371, 372, 373, 374, 375, 134, 138, 139, 140, 141, 142, 143
Tools Set	271
Toothbrush set	367
Toothbrushes	366, 367

Torch pen	94, 275
Touchscreen gloves	293
Towels	314, 336, 352
Travel mask	133
Travel pillows	370, 133
Trolley	119, 120, 122
U	
Umbrellas	296, 297, 298, 310
USB Car Charger	60
USB HUB	30, 35, 45
USB pendrive	66, 67, 68
USB port	30, 35, 45
Utility knives	277, 279
V	
Visor	314, 353
W	
Waistcoat	282
Walking Poles	345
Waste bags dispenser	286
Waterproof dry bags	341
Waterproof ponchos	294, 295
Weather station	21
Webcam cover	65
Whistle	320
Wine set	249, 250
Wireless chargers	15, 17, 29, 31, 32, 35, 37, 38, 44, 58
Wireless earphones	16, 25, 28, 39, 42, 43, 50, 51, 52, 53
Wireless Mouse	64, 65
Wireless power bank	29, 30, 38, 57
Wireless Speakers	17, 26, 27, 28, 34, 37, 39, 41, 42, 44, 46, 47, 48, 49
Wristbands	315, 351
Writing Set	73, 97
X	
XL Mouse pad	62, 312
Y	
Yoga mat	348, 349
Yoyo	257

COLOR CODES

COLOR	CODE
Aguamarine	236
Yellow	03
Hemp yellow	36
Fluor yellow	221
Heather fluor yellow	249
Golden yellow	96
Yellow corn	163
Angora (natural)	229
Tree	512
Sand	07
Dark sand	219
Denim Blue	86
Heather denim Blue	255
Electric Blue	99
Lab Blue	44
Washed Blue	126
Moonlight Blue	45
Navy Blue	55
Heather Navy Blue	247
Niagara Blue	43
Ocean Blue	100
Deep Blue	43
Riviera Blue	261
Bluish	65
Basketball	991
Bamboo	999
White	01
Pearl White	011
Blanco Vigoré	013
Burgundy	64
Borgoña Vigoré	238
Camel	85
Zebra	995
Sky Blue	10

COLOR	CODE
Chocolate	87
Copo	514
Fluor Coral	234
Heather Fluor Coral	244
Beige	29
Ebony	231
Heather Ebony	237
Star	511
Raspberry	72
France	158
Strawberry	84
Fuchsia	40
Football	992
Garnet	57
Heather Garnet	256
Heather Grey	58
Heather Light Grey	259
Dark Grey	59
Italy	161
Giraffe	997
Kiwi	990
Lime	225
Lime Yellow	118
Punch Lime	235
Heather Lime	250
Lemon	985
Apple	986
Brown	450
Mauve	63
Heather Mauve	253
Mustard	30
Heather Mustard	39
Orange	31
Naranja Bermillon	311

COLOR	CODE
Fluor Orange	223
Heather Orange	310
Black	02
Heather Black	243
Noel	515
Walnut	67
Nude	165
Gold	260
Rose Gold	281
Orchid	230
Oval	983
Fish	998
Pineapple	989
Pistachio	28
Silver	251
Lead	23
Dark Lead	46
Chicken	996
Portugal	162
Purple	71
Rectangular	981
Reno	513
Red	60
Chrysanthemum Red	262
Heather Red	245
Red Wine	116
Bubblegum Pink	34
Light Pink	48
Fluor Pink	228
Fluor Pink Lady	125
Rosette	78
Heather Rosette	252
Round	982
Royal	5

COLOR	CODE
Heather Royal	248
Watermelon	984
Snowman	516
Spain	157
Tennis	993
Tomato	987
Turquoise	12
Heather Turquoise	246
Grape	988
Bottle Green	56
Heather Bottle Green	257
Fluor Green	222
Grass Green	83
Fern Green	226
Heather Fern Green	135
Irish Green	24
Jungle Green	217
Khaki Green	13
Kelly Green	20
Lab Green	17
Mantis Green	69
Heather Mantis Green	693
Tide Green	041
Mint Green	98
Heather Mint Green	980
Army Green	15
Dark Army Green	38
Heather Army Green	153
Mist Green	264
Oasis Green	114
Sage Green	271
Path Green	124
Tropical Green	216
Wood	88

ICONOGRAPHY

 BOX	 PACK	 MEASURE	 PRINTING TECHNIQUES	 MADE TO ORDER
 BAMBOO	 RECYCLED PET	 GPS	 MESSAGE NOTIFY	 TABLET COMPARTMENT
 NATURAL JUTE	 RECYCLED ALUMINIUM	 TIME	 APP NOTIFY	 LAPTOP COMPARTMENT
 ORGANIC COTTON	 RECYCLED CARDBOARD	 APP	 FILE RECORDING	 WATERPROOF
 NATURAL WOOD	 SPEAKER	 4K 4K ULTRA HD	 DATA TRANSFER	 WATER RESIST
 NATURAL CORK	 WIRELESS CHARGER	 TACTILE	 POSITION RECORDING	 WINDPROOF
 LIMESTONE CEMENT	 RADIO FM	 TOUCH PEN	 HUMIDITY	 BPA FREE
 PLA	 WIFI	 MICRO SD	 TEMPERATURE	 ANTI PILLING
 TRITAN	 STEREO SOUND	 MICRO SIM	 HEART RATE MONITOR	 REFLECTIVE
 ANTIBACTERIAL ISO 22196	 BLUETOOTH	 CHARGER	 BLOOD PRESSURE	 REVERSIBLE
 WHEAT FIBER	 HANDS FREE	 FAST CHARGER	 OXYGEN PRESSURE	 DOUBLE WALL
 BAMBOO FIBER	 STOPWATCH	 ALARM	 RFID	 LINE IN
 BOROSILICATE GLASS	 PHONE CALLS	 LIGHT	 CALORIES COUNTER	 LIGHTNING
 HEMP	 MUSIC PLAYER	 COB LED	 PEDOMETER	 USB
 RECYCLED COTTON	 CALCULATOR	 BLINK	 SLEEP CONTROL	 USB TYPE C
 RECYCLED PAPER	 SOUND RECORDER	 CHANGING COLOR LIGHT	 SAFETY LOCK	 MICRO USB
 RECYCLED ABS (RABS)	 TIME & DATE	 VIBRATION	 BOTTLE POCKET	 FAIRTRADE COTTON

MARKING TECHNIQUES

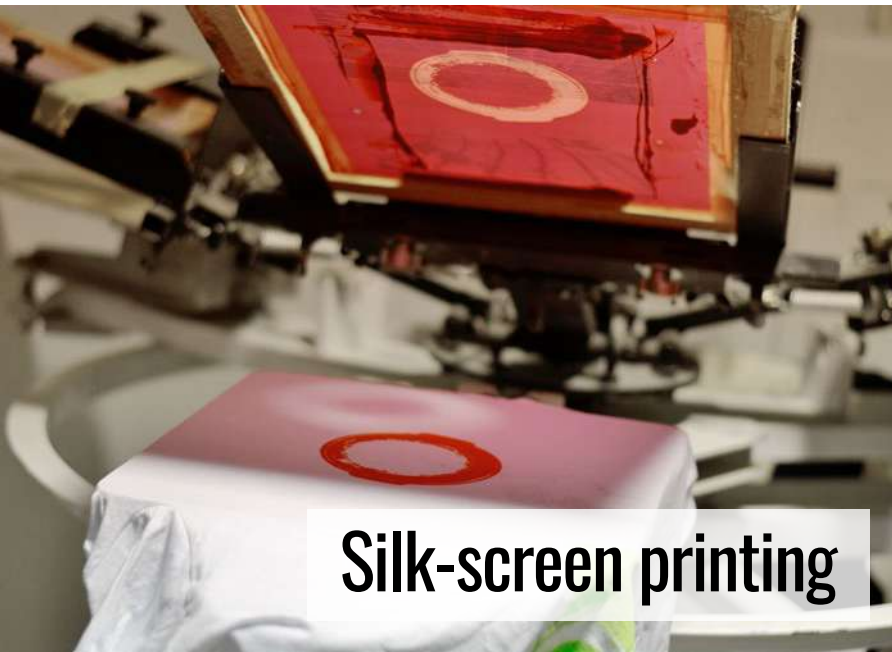

Silk-screen printing



Sublimation



Sublimation mugs

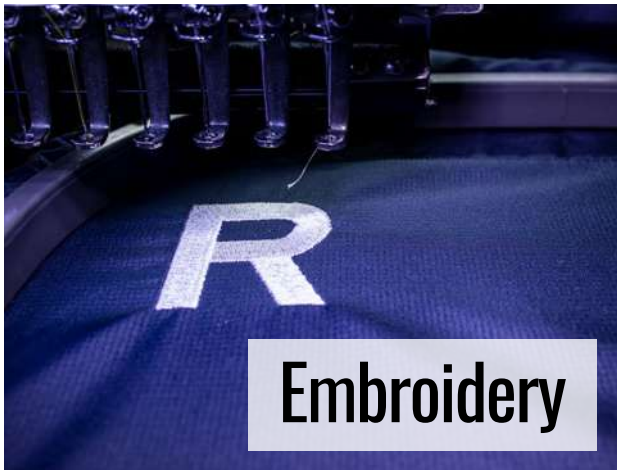

Embroidery



Transfers

Marking Code	Technique
A - K	Pad printing / Silk-screen printing
M	Offset
N	Serigraphic transfer
O	Digital transfer
Q	Sublimation mugs

R	Sublimation
T	Thermograved
U	Thermograved with colour tape
W	Digital printing
P	Embroidery
L	Laser

*We reserve the right to modify the print codes and/or number of colours published in this catalogue without prior notice.



Thermograved



Pad printing



Manipulated



Laser

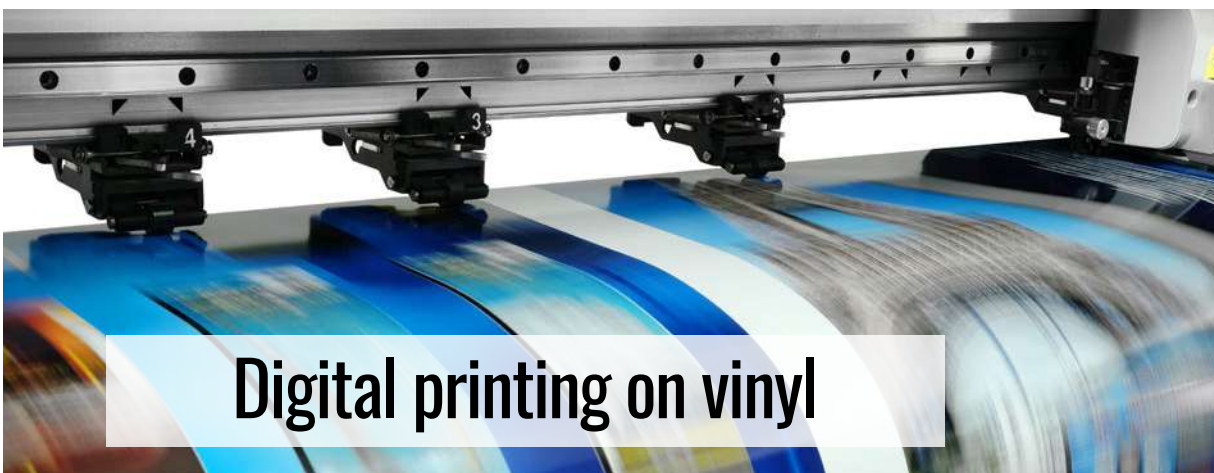

Digital printing on vinyl

**AN
UNLIMITED
PROMOTIONAL
WORLD**



+200 NOVELTIES

4206 CEDRO | PG.212



INDEX

12

TECHNOLOGY

PG. 12—69

70

WRITING & OFFICE

PG. 70—117

118

BAGS & TRAVEL

PG. 118—191

192

EATING & DRINKWARE

PG. 192—237

238

HOME, GIFTS & PREMIUM

PG. 238—269

270

TOOLS & PET CARE

PG. 270—287

288

WINTER & RAINY DAYS

PG. 288—299

300

SUBLIMATION

PG. 300—315

316

PARTY & EVENTS

PG. 316—331

332

SUMMER

PG. 332—343

344

LEISURE & SPORT

PG. 344—359

360

PERSONAL CARE

PG. 360—377

378

CHRISTMAS

PG. 378—385

386

MATERIALS

PG. 386—395

396

INDEX

PG. 396—408

1216_DUMAI ◀
PG. 364



▶ 1126_PODOX
PG. 367



▶ 7971_SIKAS
PG. 104



▲ 3045_FOLK
PG. 16



7973_ALVIK ◀
PG. 90



3991_BRICO ◀
PG. 272



▲ **3042_TANGO**
PG. 24



▶ **3985_TEIDE**
PG. 203



▶ **3984_SORBY**
PG. 271



▶ **4203_SAOKO**
PG. 214

7026_KARIN
PG. 354



▶ **4211_COIBA**
PG. 211



3114_KEROS
PG. 307



▲ **7092_AURA**
PG. 349



1040_VIZA
PG. 254

8105_BARI
PG. 333



7186_VOLANO ◀
PG. 120



PRINTING SERVICE

Customize any of our articles with our exclusive printing service.
We offer you the latest printing techniques in the market.



Direct printing



Embroidery

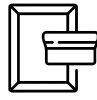

Silk-screen printing

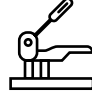

Transfers



Laser



Sublimation

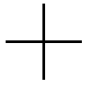

and more



OUR CERTIFICATES



NEW AND SUSTAINABLE MATERIALS

We offer you a great selection of items made of natural and recycled materials, to contribute with our responsibility to have a more sustainable world.



NATURAL
JUTE



BAMBOO



RECYCLED
LEATHER



RECYCLED
ALUMINIUM



RECYCLED
PAPER



RECYCLED
ABS



RECYCLED
PET



BAMBOO
FIBER



WHEAT
FIBER



TRITAN



LIMESTONE
CEMENT



PLA



NATURAL
WOOD



NATURAL
CORK



BOROSILICATE
GLASS



HEMP



RECYCLED
COTTON



ORGANIC
COTTON



RECYCLED
CARDBOARD

MATERIALS GUIDE PG.388

SPECIAL ATTENTION TO PRESENTATION

A picture is worth a thousand words, thus we pay attention to the smallest detail during the presentation of our products.

We exclusively design each one of our articles, giving them a different and unique characteristic.







THE FAIRTRADE SEAL FAIR TRADE AND SUSTAINABILITY

The purchase of products made with certified fair trade cotton guarantees the support of cotton growers so that they improve their quality of life and their communities, contributing to protect people and the environment.

Fairtrade certification is intended to guarantee compliance with standards related to the production or supply of a product or ingredient. The presence of the seal also means that the product is fully traceable (it has been kept isolated from non-certified products) from the growing to the customer.



MADE ^{TO} ORDER



IT'S TIME TO DESIGN

Are you looking for 100% customized article?
We **custom-make any production**, either in textiles as in gifts.
We have the necessary equipment to carry out all type of projects.
Tell us the kind of product you need and we will handle the rest.

TECHNOLOGY

RECYCLED ABS

LAMP | ALARM

NEW.



NEW NAMUR

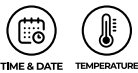

TIME & DATE TEMPERATURE

3044 **Namur**

Alarm clock lamp in recycled ABS with progressive bright light mode. Features: time, date and temperature. Led light in multiple colours. Cable included. Presentation in eco design box.

 18,5 x 14,4 x 6,6 cm

 1/10  30

 F(4), W





NEW.

- 
NATURAL
CORK
- 
BLUETOOTH
- 
SPEAKER
- 
FAST
CHARGER
- 
WIRELESS
CHARGER
- 
TACTILE
- 
TYPE C

2989 **Dravis**

Table lamp with details in cork, with in-built 10W wireless charger on the base and 3W wireless speaker. LED light with three lightning modes. Presentation in eco design box.

 33 x Ø12 cm  1  20
 F(1)

CORK
SPEAKER
LAMP





NEW.

2987 **Yarbo**

Wireless charger with structure in recycled ABS and natural cork. 10W fast charge. Type C connection. Cable included. Presentation in eco design box.

 10,4 x 2,1 x 10,4 cm

 1/50

 100

 E(4), L2, W



NEW FOLK



NEW.



NATURAL CORK



RECYCLED ABS



BLUETOOTH



HANDS FREE



TACTILE



TYPE C



3045 Folk

Wireless earbuds in recycled ABS and natural cork. Charging case with rechargeable battery. Touch control panel in-built on the earpiece. Hands-free function. Type C connection. Cable included. Presentation in eco design box.

6,7 x 5 x 3 cm

1/50

100

E(4), L2, W



3211 **Marco**

Speaker with main structure in natural cork and visible cone. 5.0 Bluetooth. 3W output. Rechargeable battery. Cable included. Presentation in eco design box.

4,6 x Ø7,90 cm 1/25 50

E(4), L1

WIRELESS CHARGING BASE



3031 **Sulac**

Wireless charger with body in natural cork and wheat fibre. DC5V. Cable included. Presentation in eco design box.





1,9 x Ø9 cm 1/50 100

E(4), L2, W



KEVEX







-  NATURAL CORK
-  FAST CHARGER
-  WIRELESS CHARGER
-  TYPE C



2994 Kevex

Wireless charger with photo frame made of cork. Ideal for 10 x 15 cm pictures. Compatible with wireless technology devices. 10 W. Cable included. Presentation in eco design box.





 17,6 x 21 cm  1  40
 E(1), L2

-  WIRELESS CHARGER
-  NATURAL CORK



3032 Promet

Pencil holder with in-built wireless charger made of natural cork. 2 additional USB ports on the back. 5W. Cable included. Presentation in eco design box.

 15,2 x 10,6 x 10,6 cm  1  20
 F(1),L2



WIRELESS CHARGER

NATURAL
CORK2993 **Lebak**

Mouse pad with natural cork surface and non-slip base.

22 x 18 cm

1/100

200

E(1), L2

LEBAK

NATURAL
CORKWIRELESS
CHARGER3030 **Alax**

Mouse pad with in-built wireless charger. Soft foldable surface in natural cork with non-slip base. DC5V. Cable included. Presentation in eco design box.

26 x 20,3 cm

1

50

F(1),L2

NEW.

NEW MARSAL



BAMBOO



FAST CHARGER



WIRELESS CHARGER



TYPE C



USB



2990 Marsal

Foldable bamboo table lamp with in-built 10W wireless charger. 25 LED lights with 3 lightning and intensity modes. Light timer from 1 to 2 hours. Presentation in eco design box.

 11 x 38,5 x 24,5 cm



1



20

 F(1), L2



3016 Celsius

Weather station with front in natural bamboo. Features: time, temperature and humidity sensors. 2 AAA batteries (not included). Presentation in eco design box.

8,6 x 12 x 2 cm 1/25 50
E(4),L1,W



3004 Kelvin

Weather station with front in bamboo. Features: clock, calendar, alarm, temperature and humidity sensors. 2 AAA batteries (not included). Presentation in eco design box.

13 x 13 x 2,4 cm 1/20 40
E(4),L2,W



NEW.

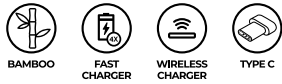

2992 **Vulco**

Wireless charger with photo frame made of bamboo. Ideal for 10 x 15 cm pictures. Compatible with wireless technology devices. 10 W. Cable included. Presentation in eco design box.

20,5 x 16,5 x 1,5 cm 1 40
 E(4), L2

CLOCK & CHARGER

NEW.



3043 **Duncer**

Table clock with 5W wireless charger in bamboo. Features: time, date, alarm and temperature. Type C connection. Cable included. Presentation in eco design box.

16 x 3,7 x 7,5 cm 1 40
 F(1), L2



ICARUS



WIRELESS CHARGER CLOCK

WIRELESS
CHARGER

ALARM



TIME & DATE



TEMPERATURE

3029 Icarus

Wireless clock docking station made of MDF. Features: Time, date, alarm and temperature. 3 lightning modes. Cable included. Presentation in eco design box.

16 x 2,9 x 7,5 cm  1  50

 E(4), L2, W





TANGO



NEW.



HANDS
FREE



TYPE C



BAMBOO

3042 **Tango**

Adjustable wireless headphones in bamboo and RPET fabric. Padded headband and ear pads. In-built touch control with stereo technology. Hand-free function. Rechargeable battery. Type C cable included. Presentation in eco design box.

12,5 x 18 x 6,5 cm 1/15 30

F(1), L2

MOON



3197 Moon

Moon-shaped speaker with wood stand. Lamp function. 3W output. LED light with different lighting modes. Cable included. Presentation in eco design box.

12 x 15 x 12 cm 1 20
 F(1), L2

SPEAKER | 3W | LED LIGHTS
DIFFERENT LIGHT MODES

Cool light

Warm light



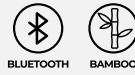

3199 **Solum**

Wireless speaker with main structure in bamboo and elegant carry strap. Hands-free function. 3W output. Rechargeable battery. Cable included. Presentation in eco design box.

8,1 x Ø6,90 cm 1 50
F(4), L1

BAMBOO SPEAKERS



3195 **Ozcan**

Wireless speaker with main structure in bamboo. Multicolour LED light with 4 lighting modes. 3W output. Rechargeable battery and cable included. Presentation in eco design box.

10,6 x Ø6,40 cm 1/25 50
E(4), L1



3206 **Kravis**

Wireless speaker with wooden body and visible cone. Ideal for laser printing. 3.0. Bluetooth. 3W output. Rechargeable battery. Cable included. Presentation in design box.

6 x 6 x 6 cm 1 50
E(4), L1





3306 **Nervo**

Wireless Bluetooth speaker with main structure in natural bamboo. Features: FM radio, hands-free and Micro SD card slot. 3W output. Rechargeable battery. Cable included. Presentation in eco design box.

5,1 x Ø6 cm 1/25 50
E(4), L1



3207 **Hardwell**

Wireless speaker with white ABS body and natural bamboo. FM radio function, hands-free, Mini SD card slot and 3W output. Rechargeable battery. Cable included. Presentation in eco design box.

4,1 x Ø7,30 cm 1 50
E(2), L1



3210 **Alesso**

Wireless Bluetooth speaker with ABS body, natural bamboo front and visible cone. Handle in imitation leather included. 3W output. Rechargeable battery. Cable included. Presentation in eco design box.

7,4 x 7 x 4,5 cm 1/25 50
E(4), L2



3206 **Blues**

Wireless 5.0 Bluetooth earbuds with charging case in natural bamboo. Multifunction touch button in-built in both earpieces. Hands-free function. Rechargeable battery. Cable included. Presentation in eco design box.

7,8 x 3,2 x 3,2 cm 1/50 100
E(4), L1, W



3018 **Soyuz**

Wireless charger with white ABS body and natural bamboo top surface. Place your Smartphone on it and let it charge. Compatible with models with wireless technology. DC5V. Cable included. Presentation in eco design box.

1 x Ø6 cm 1/50 200
 E(4), L2, W



3355 **Rossum**

5.000 mAh power bank with white ABS body and bamboo top surface. USB DC5V / 2.1A output. Micro USB cable included. Presentation in eco design box.

10,1 x 1,5 x 6,3 cm 1/25 50
 E(4), L2, W

BAMBOO ACCESSORIES



NEW.

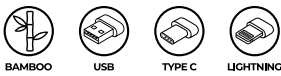

3036 **Gasly**

Keyring with 3-in-1 charging cable. Main structure in bamboo. Micro USB, Type C and lightning connection. Presentation in eco bag with window.

4 x 0,8 x 10 cm 1/100 500
 D(4), L1, W



3019 **Astro**

3-in-1 charging cable. ABS and natural bamboo body. Micro USB, Type C and Lightning connection. Presentation in brown paper bag with window.

16,5 x 1 x 2,1 cm 1/100 400
 D(1), L1



BAMBOO



USB

3023 Neptune

USB port with body in natural bamboo and white cable. 3 in-built USB ports. Presentation in eco design box.

8,5 x 1,6 x 4 cm 1/50 200

D(4), L1, W

BAMBOO POWERBANK

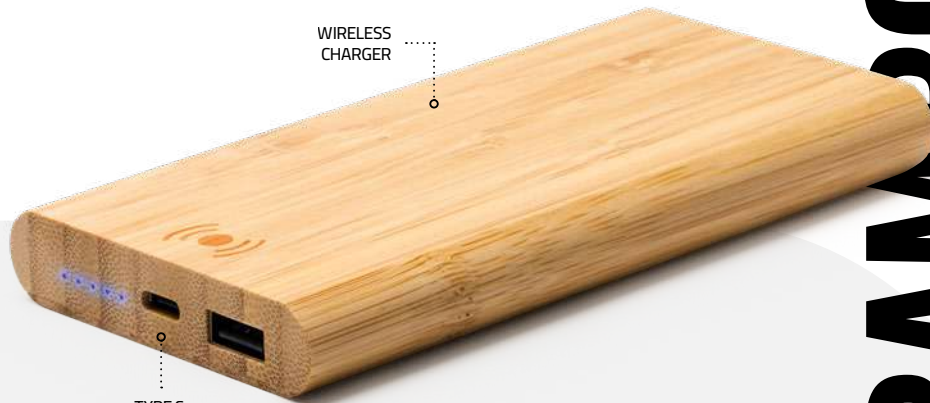

WIRELESS CHARGER

TYPE C



BAMBOO



WIRELESS CHARGER



TYPE C



USB



3349 Misty

6.000 mAh power bank with wireless charging function. Main structure in natural bamboo. DC5V/2.1A output. Wireless DC5V. Type C cable included. Presentation in eco design box.

7,5 x 14,5 x 1,6 cm

1/20

40

E(4), L2, W





WIRELESS CHARGER

BAMBOO COLLECTION



BAMBOO

WIRELESS CHARGER

3024 Core

Wireless charger in natural bamboo, in-built on a desk tray. Compatible with wireless technology models. DC5V. White cable included. Presentation in eco design box.

27 x 1,5 x 14,5 cm 1

20

E(1), L2, W



BAMBOO

WIRELESS CHARGER

USB

TYPE C

3001 Nebula

Wireless charger in natural bamboo. Charging capacity: up to 3 devices simultaneously. Compatible with wireless technology models. DC5V. DC5V/2.1A USB output port. Presentation in eco design box.

9 x 1 x 9 cm 1/25

50

E(4),L2,W

2 USB 3.0 PORTS



BAMBOO



WIRELESS CHARGER

3022 Gravity

Wireless charger with body in natural bamboo. Place your Smartphone on it and let it charge. Compatible with wireless technology models. DC5V. Cable included. Presentation in eco design box.

7 x 11,5 x 8 cm 1/25 50

E(4), L2

WIRELESS CHARGER



ECO DESIGN



BAMBOO



WIRELESS CHARGER



3027 Gamma

Wireless charger with stand for mobiles and tablets made of natural bamboo. DC5V. 1 m cable included. Presentation in eco design box.

12,5 x 8 x 1,6 cm 1/50 100

E(4), L2, W

WIRELESS CHARGER





3055 **Antix**

Stand for mobiles, tablets or Smartphones made of natural bamboo.

 6 x 2 x 8 cm

 1/50

 200

 D(4), L1, W

BAMBOO HOLDERS



3010 **Lyra**

Mobile stand in natural bamboo. Lower gap for the charging cable. 2 easy-assembly parts included.

 8 x 8,1 x 12 cm

 1/50

 100

 D(4), L2, W



NEW.



3194 **Takay**

Wireless speaker with main structure in bamboo and RPET fabric. 3W output and rechargeable battery. Type C connection. Cable included. Presentation in eco design box.

5,3 x Ø6 cm 1/25 50
 F(1), L2



3193 **Bemol**

Wireless speaker with main structure in bamboo and RPET fabric. 3W output and rechargeable battery. Type C connection. Cable included. Presentation in eco design box.

9,5 x 9,5 x 5,2 cm 1/10 30
 F(1), L2



NEW
BEMOL



NEW.



BAMBOO

RECYCLED
PETFAST
CHARGERWIRELESS
CHARGER

TYPE C

2988 **Sibon**

Wireless charger with main structure in bamboo and RPET fabric, compatible with wireless technology devices. 10W output. Type C connection. Cable included. Presentation in eco design box.

0,8 x Ø9,80 cm 1/50 100

F(1), L2

RPET + BAMBOO



NEW.



BAMBOO

RECYCLED
PET

USB



TYPE C

3039 **Badoc**

HUB port with main structure in bamboo and RPET fabric. 2 in-built USB and USB type C ports included. Presentation in eco design box.

8,2 x 1,2 x 2,6 cm 1/50 200

E(1), L2



CEMENT COLLECTION



3021 Mars

Wireless charger with body in natural bamboo and base in limestone cement. Place your Smartphone on it and let it charge. Compatible with wireless technology models. DC5V. Cable included. Presentation in eco design box.

9,4 x 12,5 x 9,4 cm

1/15 30

E(1), L2



3209 Heldens

Bluetooth speaker with wireless charging base and visible cone. Body in limestone cement and top surface in natural bamboo. 5W speaker output and DC5V wireless charger. Rechargeable battery. Cable included. Presentation in eco design box.

11,8 x 7,8 x 6,5 cm

1/10 20

F(4), L2



3208 Steve

Wireless speaker with body in limestone cement and top surface in natural bamboo. 5.0 Bluetooth, 3W output and rechargeable battery. Charging cable included. Presentation in eco design box.

7,2 x Ø7 cm

1/15 30

E(4), L2





2999 **Zibal**

Wireless charger with recycled ABS body and RPET fabric surface. Place your Smartphone on it and let it charge. Compatible with models with wireless charging technology. 10W. Micro USB cable included. Presentation in eco design box.

Ø10 cm

1/50

100

E(1), W

RECYCLED ABS + RPET

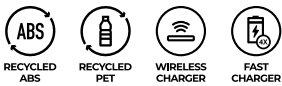

3356 **Dilbar**

8.000 mAh power bank with recycled ABS body and RPET fabric surface. USB DC5V / 2.1A output port. Wireless 10 W. Micro USB cable included. Presentation in eco design box.

13,5 x 1,5 x 7,1 cm

1/20

40

F(1), N(8)





3311 **Elson**

Wireless speaker in recycled ABS. 5.0 Bluetooth. 3W output. Rechargeable battery. Cable included. Presentation in eco design box.

6,2 x Ø6,20 cm 1/25 50
E(1)



LED LIGHT

ELSON

VAIDI



CHARGING CASE



3312 **Valdi**

Wireless 5.0 Bluetooth earbuds with charging case in recycled ABS and surface of the case in bamboo. Control panel with touch technology in-built in the earpiece. Hands-free function. Case with rechargeable battery and magnetized lid. Micro USB cable included. Presentation in eco design box.

6,5 x 2,6 x 3,6 cm 1 50
E(4), L1, W

TACTIL

NEW DEMAR

NEW.



- RECYCLED PET
- WIRELESS CHARGER
- FAST CHARGER
- TYPE C



3038 Demar

Mouse pad in RPET with in-built 10W wireless charger. Mobile and pen stands included. Presentation in eco design box.

31 x 0,8 x 27 cm 1/10 20

F(1), N(8)



3192 **Tenor**

Wireless speaker in RPET fabric with wireless 5W dock station. 3W output. Type C connection. Cable included. Presentation in eco design box.

8 x Ø9,30 cm 1/10 30

F(1)

NEW.



BLUETOOTH SPEAKER



3310 **Custik**

Wireless speaker with main structure in RPET fabric and visible cone. 5.0 Bluetooth. 3W output. Rechargeable battery. Cable included. Presentation in eco design box.

4,6 x Ø7,90 cm 1/25 50

F(4)



TACTILE



WHEAT FIBER



BAMBOO



BLUETOOTH



HANDS FREE



TACTILE



TYPE C

3041 Kuasi

Wireless earbuds in wheat fibre and bamboo, with charging case. In-built control panel with touch technology. Hands-free function. Rechargeable battery. Type C cable included. Presentation in eco design box.

3,9 x 2,3 x 3,7 cm 1/50 100

E(4), W



CHARGING CASE

..... TACTILE



WHEAT FIBER



BLUETOOTH



HANDS FREE



TACTILE

3309 Burak

Wireless 5.0 Bluetooth earbuds in wheat fibre with charging case. Control panel with touch technology in-built in the earpiece. Hands-free function. Case with rechargeable battery and magnetized lid. Cable included. Presentation in eco design box.

6,8 x 2,2 x 4,5 cm 1/50 100

E(4), W

FAST CHARGER



WHEAT FIBER



BAMBOO



BLUETOOTH



HANDS FREE



WIRELESS CHARGER



FAST CHARGER

3308 Zatox

Bluetooth speaker with wireless charging base. Main structure in wheat fibre and natural bamboo surface. DC5V 10W wireless output. Rechargeable battery. Presentation in eco design box.

16 x 6 x 7,8 cm 1/15 30

F(4), L2

NORBY

WHEAT FIBER | FOLDABLE | HANDS FREE

HEADPHONES



3035 **Norby**

Wireless headphones in wheat fibre. Upper padding and leatherette ear pads. In-built control panel with stereo technology. Hands-free function and FM radio. Rechargeable battery. Cable included. Presentation in eco design box.

17 x 7,5 x 18,5 cm 1/10 20

F(1)

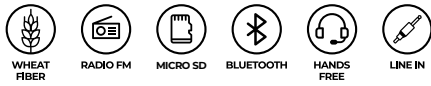

3198 **Kumber**

Wireless speaker made of wheat fibre. FM radio, micro SD card slot and hands-free function. 3W output. Cable included. Presentation in eco design box.

5 x Ø6 cm 1/25 50
E(4)



2996 **Vatox**

Wireless charging base made of wheat fibre. Compatible with wireless technology devices. 5W. Micro USB cable included. Presentation in eco design box.

1 x Ø7 cm 1/50 100
E(4), W



3057 **Bawen**

Foldable mobile stand in wheat fibre with anti-slip edges.

8,8 x 8,8 x 3 cm 1/100 500
B(4), W



WHEAT FIBER LINE

PLASTICS REDUCTION



3034 Gospek

HUB port made of wheat fibre with 4 in-built USB ports.
Presentation in eco design box.

1,8 x Ø5,20 cm 1/50 200

D(4), W



2995 Melbux

Multifunton pencil holder made of wheat fibre with Smartphone stand, wireless DC5V charger and three in-built USB ports. Micro USB cable included. Presentation in eco design box.

8,5 x 9 x 10 cm 1/25 50

E(1), W



UMEK

10W | PREMIUM FABRIC | LED LIGHTS



BLUETOOTH

HANDS
FREE

TYPE C

CHANGING
COLOR LIGHT

LINE IN

3196 Umek

Design wireless speaker in a premium fabric finish. Transparent membrane with 6 LED lighting modes. 10W output. Resistant carry strap and plaque for laser printing included. Rechargeable long-lasting battery. Cable included. Presentation in design box.

18,5 x Ø7,50 cm 1/10 20

F(1), L2



NEW.



BLUETOOTH

HANDS
FREEWIRELESS
CHARGERWATER
RESIST

LINE IN



TYPE C

3191 **Sakura**

Speaker/Power bank with 5W wireless charge function.
10W output. IPX7 waterproof speaker. Type C connection.
Cable included. Presentation in design box.

19,9 x 8,5 x 9,1 cm

1/5

10

F(1), W



LED LIGHT



3203 **Vandik**

Wireless 5.0 Bluetooth speaker in white rubber touch finish and matching colour mesh. Touch control panel and multicoloured LED light at the base, with random activation to the rhythm of the music. Hands-free function. 3W output. Rechargeable battery. Cable included. Presentation in design box.

10,6 x Ø7,10 cm 1 50
E(1)



3204 **Armin**

Two-colour wireless Bluetooth speaker. Body in matt rubber touch finish. Carry strap, buttons and mesh in matching colour. 3W output. Rechargeable battery. Cable included. Presentation in design box.

11,1 x 8,3 x 4,1 cm 1/1 50
E(1)





3202 Calvin

Wireless speaker with ABS body resistant to water splashes. Fixing by suction cup. Hands-free function. 3W output. Rechargeable battery by Micro USB cable. Cable included. Presentation in design box.

5,5 x Ø8,50 cm 1 50
F(1)



3200 Cox

Wireless ABS speaker in soft touch finish. 3.0 Bluetooth. 3W output. Hands-free function Rechargeable battery. Cable included. Presentation in design box.

7,5 x Ø6 cm 1 50
F(1)



MICRO SD



3201 Garrix

Wireless speaker with metallic body in matt finish. 3.0 Bluetooth, FM radio and hands-free function. 3W output. Rechargeable battery. Cable included. Presentation in design box.

5 x Ø5,90 cm 1/25 50
E(4), L1





WIRELESS EARPHONES
BLUETOOTH | FOLDABLE



3150 **Legrand**

Wireless 5.0 Bluetooth headphones with rubber touch finish. Foldable. Upper padding and soft leatherette ear pads. Aluminium sides, ideal for laser printing. In-built control panel with stereo technology. Hands-free function and FM radio. Rechargeable battery. Cable included. Presentation in white sash design box.

19 x 18,5 x 7,7 cm 1/10 20

F(1), L2

LEGRAND



60 05 02 01



3151 **Rayel**

Wireless 5.0 Bluetooth headphones in rubber touch finish. Foldable. Upper padding and soft leatherette ear pads. Aluminium sides, ideal for laser printing. In-built control panel and stereo technology. Hands-free function and FM radio. Rechargeable battery. Cable included. Presentation in design box.

19 x 17,5 x 8 cm 1/10 20

F(1)

FOLDABLE



NEW TACET

NOISE CANCELLING | BLUETOOTH



BLUETOOTH



HANDS
FREE

TYPE C

TACTILE

3040 Tacet

Wireless noise-cancelling earbuds. In-built control panel with touch technology. Hands-free function. Charging case with rechargeable battery and Type C connection. Cable included. Presentation in design box.

 5,9 x 5,3 x 2,9 cm  1/50  100

 E(4), W



NEW COSTEN



3037 Costen

Wireless earbuds with charging case. In-built control panel with touch technology. Hands-free function. Rechargeable battery with Type C connection. Cable included. Presentation in design box.

4,6 x 4,6 x 2,3 cm 1/50 100
E(4), W



FUNK



LCD DISPLAY



CHARGING CASE

3307 Funk

Wireless 5.0 Bluetooth earbuds with charging case. LED display in the case and in-built multifunction button in both earpieces. Hands-free function. Case in matt finish design and rechargeable battery. Cable included. Presentation in design box.

6,2 x 2,8 x 4 cm 1/50 100
E(4), W

WIRELESS CHARGING TECHNOLOGY



3025 Trap

Wireless 5.0 Bluetooth earbuds with charging case. In-built multifunction button in both earphones. Hands-free function. Wireless rechargeable battery. Cable included. Presentation in design box.

7,5 x 3,2 x 3,2 cm 1/50 100
E(4), W

TACTILE

CHARGING CASE

CHARGING CASE

BLUETOOTH
 HANDS FREE
 WHEAT FIBER
 STEREO SOUND
 TACTILE

3309 Burak

Wireless 5.0 Bluetooth earbuds in wheat fibre with charging case. Control panel with touch technology in-built in the earpiece. Hands-free function. Case with rechargeable battery and magnetized lid. Cable included. Presentation in eco design box.

6,8 x 2,2 x 4,5 cm 1/50 100
 E(4), W

CHARGING CASE

TACTILE

BLUETOOTH
 HANDS FREE
 STEREO SOUND
 TACTILE

3305 Ferry

Wireless 5.0 Bluetooth earbuds with charging case in elegant white gloss finish. Control panel with touch technology in-built in the earpiece. Hands-free function. Case with rechargeable battery and magnetized lid. Cable included. Presentation in design box.

6,8 x 2,2 x 4,5 cm 1/50 100
 E(4), W

BLUETOOTH EARPHONES + CHARGING CASE

CHARGING CASE

TACTILE

- BLUETOOTH
 HANDS FREE
 BAMBOO
 STEREO SOUND
 TACTILE

3026 Blues

Wireless 5.0 Bluetooth earbuds with charging case in natural bamboo. Multifunction touch button in-built in both earpieces. Hands-free function. Rechargeable battery. Cable included. Presentation in eco design box.

7,8 x 3,2 x 3,2 cm 1/50 100
 E(4), L1, W



01



02



3302 **Kura**

Wireless earphones with in-built control panel and microphone. Stereo sound. Presentation in a practical zippered case in synthetic leather. Rechargeable battery. Cable included.

3,9 x Ø8 cm

1/50

200

E(1), G(4)

EARPHONES



3301 **Punk**

Earphones presented in a practical transparent PVC case with air-tight seal. 3,5 mm jack connection. Cable with security button included.

8 x 7,8 x 1,2 cm

1/50

500

E(1)

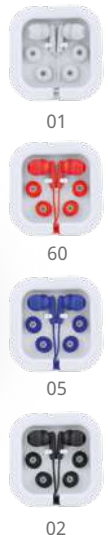

3300 **Aoki**

Earphones in a PS case. 3,5 mm jack connection. Cable with security button and 3 pairs of ear adaptors in different sizes included.

7 x 7 x 2 cm

1/50

500

D(1), W

MULTI FUCTION SMART WATCHES



DRACO_3401

WILLMAN_3402

NORA_3405



- BLUETOOTH
- CALORIES COUNTER
- PEDOMETER
- SLEEP CONTROL
- MESSAGE NOTIFY
- HEART RATE MONITOR
- APP
- REMOTE CAMERA

3401 Draco

Smartwatch with activity functions. TPU body and TFT colour display. Adjustable silicone strap and metal buckle. Heart rate monitoring. Bluetooth connection with APP for iOS and Android. USB charging cable included. Presentation in design box.

26 x 1,9 x 1,2 cm 1/50 100
I(1), L2

- BLUETOOTH
- CALORIES COUNTER
- PEDOMETER
- SLEEP CONTROL
- MESSAGE NOTIFY
- HEART RATE MONITOR
- APP
- REMOTE CAMERA

3402 Willman

Smartwatch with activity functions. TPU body and 1.3" TFT colour display with in-built charging USB. Adjustable silicone strap and metal buckle. Heart rate monitoring. Bluetooth connection with APP for iOS and Android. Presentation in design box.

25 x 1,1 x 3,4 cm 1 50
I(1), L2

- BLUETOOTH
- CALORIES COUNTER
- PEDOMETER
- SLEEP CONTROL
- HEART RATE MONITOR
- STOPWATCH
- APP
- BLOOD PRESSURE
- MUSIC PLAYER
- PHONE CALLS
- OXYGEN PRESSURE
- TACTILE

3405 Nora

Smartwatch with activity functions. Adjustable TPU strap and IPS touch screen. Heart rate monitoring and call control. Bluetooth APP for iOS and Android. USB cable included. Presentation in design box.

27 x 1,2 x 3,9 cm 1 50
I(1), L2



2100 **Discovery**

Sports camera with 4K HD video technology and Wi-Fi connection. 2" LCD screen with full HD 1080P photo camera function. Includes rugged case submersible up to 30 m and an assortment of multifunction accessories. Rechargeable and removable battery. Cable included. Presentation in design box.

6 x 4,2 x 3 cm 1 20
 K(4)



4K CAMERA
DISCOVERY

DROIDE



01 03 60 05 02 226 0

PRINTING ZONE



3354 **Droide**

4.000 mAh solar battery. LED charging and light indicator. DC5V/2.1A output. Micro USB cable included. Presentation in design box.

7,5 x 14,5 x 1,5 cm

E(2)

1/20 40

CARABINER INCLUDED





SPECIAL FOR DIGITAL PRINTING



0101

6001

0501

22601

3352 Robbie

Two-colour ABS external battery with 10.000 mAh. LED charging indicator. DC5V / 2.1A output. Micro USB cable included. Presentation in design box.

14,4 x 1,4 x 7,7 cm

1/10

40

E(4), W



01

60

05

251

02

3350 Bender

External aluminium battery with 2.600 mAh capacity. LED charging indicator. Cable with USB and Micro USB connection included. Presentation in design box.

9,4 x 2,1 x 2,2 cm

1/25

100

D(4), L1, W

EXTERNAL BATTERY



SUCTION CUPS



SPECIAL FOR DIGITAL PRINTING



3353 Hal

ABS power bank with 5.000 mAh charging capacity. Fixing function by suction cups. LED charging indicator. DC5V / 2.1A USB output. Wireless DC5V / 1A. Micro USB cable included. Presentation in design box.

10,4 x 6,5 x 1,6 cm

1/25

50

F(4), W



3355 Rossum

5.000 mAh power bank with white ABS body and bamboo top surface. USB DC5V / 2.1A output. Micro USB cable included. Presentation in eco design box.

10,1 x 1,5 x 6,3 cm

1/25

50

E(4), L2, W

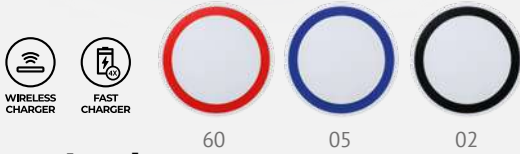

3003 Lander

Wireless charging base for Smartphone. Connect the device, place your Smartphone on it and let it charge. Compatible with models with wireless charging technology. 10 W. Cable included. Presentation in design box

1 x Ø7 cm 1/50 200
E(4), W



2996 Vatox

Wireless charging base made of wheat fibre. Compatible with wireless technology devices. 5W. Micro USB cable included. Presentation in eco design box.

1 x Ø7 cm 1/50 100
E(4), W



3018 Soyuz

Wireless charger with white ABS body and natural bamboo top surface. Place your Smartphone on it and let it charge. Compatible with models with wireless technology. DC5V. Cable included. Presentation in eco design box.

1 x Ø6 cm 1/50 200
E(4), L2, W



ALUMINIUM



3005 Falcon

Wireless charger with aluminium body. Connect the device, place your smartphone on it and let it charge. A light will indicate the charging is taking place. Compatible with models with wireless charging technology. DC5V / 1.0A. Cable included. Presentation in design box.

7 x Ø9,80 cm 1/50 100
E(1), L1, W



3033 **Plerion**



USB hub with aluminium structure, two-colour finish and white cable. 4 in-built USB hub. Presentation in white box.

8,9 x 3,7 x 2,1 cm 1/50 200

D(4), L1

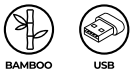

3023 **Neptune**

USB port with body in natural bamboo and white cable. 3 in-built USB ports. Presentation in eco design box.

8,5 x 1,6 x 4 cm 1/50 200

D(4), L1, W



NEW.



3039 **Badoc**

HUB port with main structure in bamboo and RPET fabric. 2 in-built USB and USB type C ports included. Presentation in eco design box.

8,2 x 1,2 x 2,6 cm 1/50 200

E(1), L2



3019 **Astro**

3-in-1 charging cable. ABS and natural bamboo body. Micro USB, Type C and Lightning connection. Presentation in brown paper bag with window.

16,5 x 1 x 2,1 cm 1/100 400

D(1), L1



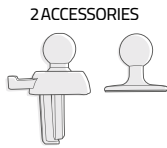

3054 **Hydra**

Smartphone holder with wireless car charger. Connect the device, place the phone on it and let it charge. Compatible with models with wireless charging technology. Cable included. 10W speed charge. DC5V / 1.0A. Presentation in design box.

8,5 x 10 x 9,4 cm 1 50
E(1)



60 05 02 01



3000 **Tardis**

USB charger set, car and wall. Presentation in a zippered PU case. Charging speed: 1.000 mAh

8 x 4,2 x 6,3 cm 1/50 200
C(4), E(1)



01 02

3013 **Bopp**

Universal travel adapter with compact and retractable design, in matt finish and soft touch. Europe, Asia, United Kingdom, USA, Australia. 2 USB ports 2.100 mAh charging speed. Presentation in white box.

6,1 x 5,6 x 4,5 cm 1/50 100
D(1), W



60 60

05 02

3014 **Gordon**

Universal travel adapter for Europe, Asia, United Kingdom, USA, Australia. Presentation in white box.

8,2 x Ø4,50 cm 1/50 100
D(4)



3010 **Lyra**

Mobile stand in natural bamboo. Lower gap for the charging cable. 2 easy-assembly parts included.

8 x 8,1 x 12 cm 1/50 100

D(4), L2, W



3055 **Antix**

Stand for mobiles, tablets or Smartphones made of natural bamboo.

6 x 2 x 8 cm 1/50 200

D(4), L1, W



3056 **Kunir**

Foldable mobile stand with anti-slip edges.

8,8 x 8,8 x 3 cm 1/100 500

B(4), W



3057 **Bawen**

Foldable mobile stand in wheat fibre with anti-slip edges.

8,8 x 8,8 x 3 cm 1/100 500

B(4), W

SUBLIMATION



2998 **Sonic**

XL mouse pad. Soft polyester surface, special for sublimation, and non-slip base. Individual presentation.

70 x 35 cm 1/10 30
F(1), R



MOUSEPADS

SUBLIMATION



2997 **Yuba**

Round mouse pad. Soft polyester surface and non-slip base.

Ø20 cm 1/100 200
E(1), N(8), R



SONIC MOUSE PAD

EXTRA LARGE | SPECIAL FOR SUBLIMATION

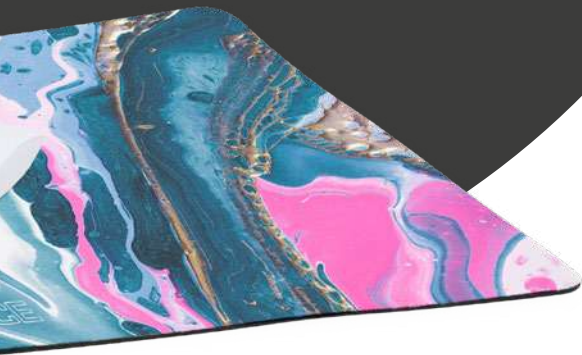

SUBLIMATION



01

03

60

05

226

02

3011 Sira

Flat design mouse pad. Soft polyester surface and non-slip rubber base.

22 x 18 cm

1/100

200

E(1), N(8), R

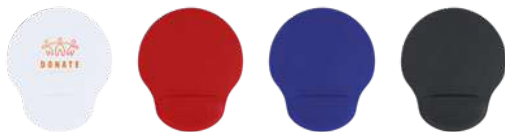

01

60

05

02

3012 Silvano

Mouse pad made of soft polyester with padded wrist rest. Non-slip rubber base.

20,5 x 24,3 x 2 cm

1

100

E(1), N(8), R



PADDED

NEW REMY

BAMBOO | RECYCLED ABS



3049 **Remy**

Wireless mouse in bamboo and recycled ABS with precision optical sensor. 2 AA batteries not included. Presentation in eco design box.

 10,2 x 3,4 x 5,8 cm  1/50  200

 E (1), W



3050 **Kasper**

Cover for mobile device camera or webcam. Sliding mechanism and reusable 3M adhesive.

3,2 x 1,3 x 0,1 cm 100 10000
B(1), W



3052 **Jerry**

Wireless folding mouse with precision optical sensor. Ergonomic design with rubber touch surface. 2 AAA batteries not included. Presentation in white box.

10,8 x 3,6 x 6 cm 1/50 100
E(1), W



FOLDABLE



3051 **Stuart**

Wireless mouse with precision optical sensor and in-built DPI button. Surface with rubber touch finish. 2 AAA batteries not included. Presentation in white box.

11,2 x 2,4 x 5,7 cm 1/100 200
E(4), W

USB STOCK

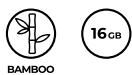

4189 **Percy**

USB memory stick with body and swivel clip in natural bamboo. Presentation in eco box.

6,3 x 3,2 x 1,3 cm 1/50 300

D(4), L1



4190 **Uldon**

USB memory stick with body in natural bamboo and metal swivel clip. Presentation in eco box.

5,7 x 2 x 1,2 cm 1/50 300

D(4), L1



NEW.



4196 **Vibo**

USB memory stick in recycled cardboard with metal swivel clip. Presentation in eco design box.

5,8 x 2 x 1 cm 1/50 500

D(4), L1



NEW.

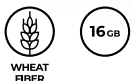

4194 **Venak**

USB memory stick in wheat fibre with metal swivel clip. Presentation in eco design box.

5,7 x 1,9 x 0,9 cm 1/50 500

D(4), L1



NEW.



4193 **Kinnox**

USB memory stick with main structure and swivel clip in wheat fibre. Presentation in eco design box.

5,9 x 1,7 x 0,9 cm 1/50 500

D(4), W

USBSTOCK



NEW.



16 GB

BAMBOO



4191 Gudard

USB memory stick with main structure in natural bamboo. Presentation in eco design box.

6,4 x 2,2 x 1,3 cm 1/50 500

D(4), L1, W



NEW.



16 GB

BAMBOO



4198 Netix

USB memory stick with main structure in bamboo. Presentation in eco design box.

5,8 x 1,4 x 0,6 cm 1/50 500

D(4), L1, W



NEW.



16 GB

NATURAL WOOD



4197 Ledes

USB memory stick in recycled cardboard with case in natural cork. Presentation in eco design box.

7 x 2,9 x 0,5 cm 1/50 500

D(4), L1, W



NEW.

16 GB

4195 Viken

Cylindrical USB memory stick in recycled cardboard. Presentation in eco design box.

6,7 x Ø1,8 cm 1/50 500

D(4), W

USBSTOCK

NEW.



16CB

4192 Riot

USB memory stick with main structure in ABS and matching swivel clip. Presentation in box with window.

5,7 x 0,9 x 1,9 cm 1/50 500
D(4), L1

16CB 32CB



4188 Roy

Metal USB memory stick in ultra compact design. Presentation in matt white paper box.

3,8 x 0,4 x 1,2 cm 1/100 1000
D(4), L1

USB FLASH DRIVES



16CB 32CB

4186 Marvin

USB memory stick in a classic design with ABS body and metal swivel clip. Presentation in matt white paper box with window.

5,7 x 0,9 x 1,9 cm 1/50 300
D(4), L1

16CB



4187 Cylon

Aluminium USB memory stick in extra thin design in the shape of a key. Presentation in metal box with window.

5,7 x 0,3 x 2,4 cm 1 200
D(4), L1

USB 2023

MADE TO ORDER



REQUEST OUR WEEKLY RATE

Models with up to 64Gb of capacity. OTG models, 3.0 connection. Custom 2D and 3D designs.
Quotes in 24-48h.



Free standard presentation box



File recording service



Free special pantone color from
500 units *
(*Check available models)

WRITING & OFFICE

FE



7993 **Reydon** 

Elegant twist roller pen and propelling pencil set, in a dark steel design. Presentation in a padded leather case with inner lining. Blue ink.

 13,6 x Ø1,10 cm  1/25  50

 C(1), D(4), L1

WRITING









NATURAL
CORK



7991 **Alton** 

Twist ball pen with body in natural cork and steel. Chrome plated details. Blue ink. Presentation in eco design box.

 13,6 x Ø1,10 cm  1/50  300

 B(4), L1



CORK PENS



NATURAL
CORK

8044 **Artur** 

Elegant metal ball pen in chrome plated finish and cork grip. Presentation in a cork case. Metal jumbo refill with blue ink.

 13,9 x Ø1,10 cm  1  200

 D(1), L1



NATURAL
CORK

7992 **Suver** 

Roller pen in natural cork and steel. Presentation in an elegant cork combined case with padded inner lining. Blue ink.

 13,8 x Ø1,10 cm  1/50  100

 C(1), D(4), L1





BAMBOO



8041 **Bodoni**

Twist ball pen made of bamboo with stainless steel details. Presentation in a bamboo case with magnetic clasp. Blue ink.

17,5 x 2,5 x 5,7 cm

1/25 100

D(4), L2



BAMBOO PENS



BAMBOO

8036 **Kioto**

Pen and propelling pencil set made of bamboo, with push button and blue ink. Presentation in a wood effect cardboard box.

17 x 2,2 x 4,1 cm 20

200

C(4), D(4), L1



8093 **Besky**

Ball pen with body in bamboo and push button in metal finish. Blue ink jumbo refill.

14 x Ø1,10 cm 1/50 1000

B(4)



8018 **Tucuma**

8019 **Pampa**

7986 **Davos**

NEW.

BAMBOO LINE



01 60 05 226 02



BAMBOO

8018 **Tucuma** 

Ball pen with natural bamboo body and design details in plated finish. Blue ink.

 13,9 x Ø1,10 cm  1/50  1000

 B(4), L1



BAMBOO



TOUCH PEN

8019 **Pampa** 

Ballpoint pen with natural bamboo body, metal clip and touch pointer. Jumbo refill in blue ink.

 14,8 x Ø1 cm  1/50  1000

 B(4), L1



BAMBOO

7986 **Davos** 

Bamboo ball pen with push button and metal details. Blue ink.

 13,8 x Ø1,10 cm  1/50  1000

 B(4), L1

8034 **Stoa**

8080 **Gildon**

8084 **Nagoya**



2929 0329 3129 6029 24229 11429



8034 **Stoa**

Push button pen with bamboo body and tip, clip and push button in wheat fibre / ABS. Blue ink.

14,1 x Ø1 cm 1/50 1000
 B(4), L1

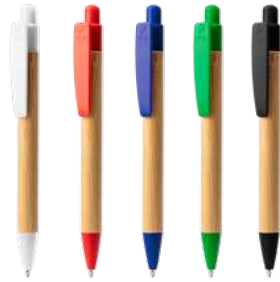

01 60 05 226 02



8080 **Gildon**

Ball pen with body in bamboo and PLA. Blue ink.

14 x Ø1 cm 50 1000
 B(4), L1



29 03 60 114 242 02



8084 **Nagoya**

Retractable pen with bamboo body, details in bamboo fibre and metallic clip. Touch pointer included. Blue ink.

14 x Ø1,50 cm 1/50 1000
 B(4), L1

NEW.



BAMBOO

7982 **Penta** 

Metal ball pen in matt finish with bamboo grip and dark colour details. Blue ink.

 14,3 x Ø1 cm  1/50  1000

 B(4), L1



01 31 49 71 242 226 02

NEW PENS

NEW.



BAMBOO

7990 **Olten** 

Metal ball pen in matt finish with bamboo grip and touch pointer. Blue ink.

 14,5 x Ø1 cm  1/50  500

 B(4), L1



01 55 47 02

NEW ROLLER PIRGO



NEW.



BAMBOO

7983 **Pirgo** 

Roller pen with bamboo body and metal details. Jumbo refill in blue ink.

 13,8 x Ø1,10 cm  1/50  1000

 B(4),L1



01 03 60 05 226 02



8017 **Coloma** 

Rollerball pen with soft ABS body. Metal clip and tip. Jumbo refill in blue ink.

 14,3 x Ø1,10 cm  1/50  1000

 A(4)



01 03 60 05 02



8021 **Yama** 

Rollerball pen with metal clip and details in silver. Blue refill in blue ink.

 13,5 x Ø1,10 cm  1/50  1000

 A(4)



8076 **Conwi**

8009 **Merlin**

8031 **Sagano**

8025 **Lika**

8028 **Gorbea**



251 29



8025 **Lika**

Rotary ball pen in wheat fiber and PP with black finishes. Blue ink.

14 x Ø1,30 cm 1/50 1000
 A(4)



8031 **Sagano**

Ball pen in bamboo with push button. Blue ink jumbo refill.

14 x Ø1,30 cm 1/50 1000
 A(4), L1



8028 **Gorbea**

Ball pen with push button, made of wheat fibre and ABS. Blue ink.

14 x Ø1,30 cm 1/50 1000
 A(4)



01 03 31 60 40 05 242 114 226 02

8009 **Merlin**

Retractable pen made of ABS with soft grip. Blue ink.

14 x Ø1,30 cm 1/50 1000
 A(4)



01 03 31 60 40 05 226 02

8076 **Conwi**

Ball pen with body in silver ABS and soft grip in translucent colour. Black ink.

14 x Ø1,30 cm 1/50 1000
 A(4)

+ antibacterial
ISO 22196



01



03 31 60 05 226 02



01 60 05 02



8038 Newton 

Antibacterial ballpen made of ABS. Manufactured according to ISO 22196: 2011 standard. Blue ink.

 14 x Ø1,30 cm  1/50  1000

 A(4)



8039 Carrel 

Antibacterial ballpen with ABS body and soft colour grip in translucent finish. Blue ink. Manufactured according to ISO 22196: 2011 standard.

 14 x Ø1,30 cm  1/50  1000

 A(4)



8022 Farber 

Antibacterial sprayer ballpen with rechargeable spray and pointer. 3 ml capacity (liquid not included). Blue ink.

 16 x Ø1,50 cm  1/50  1000

 B(4)



8040 Stark

8045 Hindres

8010 Stix

8035 Kamut



03 31 60 05 114 226 40 02

8045 Hindres

Retractable pen made of ABS. Body in white and clip in different colours. Blue ink refill.

13,8 x Ø1 cm 1/50 1000
A(4)

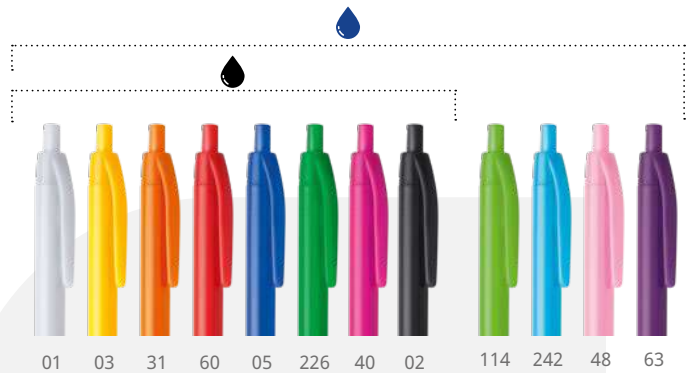

01 03 31 60 05 226 40 02 114 242 48 63

8010 Stix

Retractable pen made of ABS in assorted colours. Available in blue and black ink.

13,8 x Ø1 cm 1/50 1000
A(4)

+ antibacterial
ISO 22196

+ anti bacterial
ISO 22196

8040 Stark

Ballpoint pen with antibacterial ABS body and blue ink. ISO 22196 standard compliance.

13,8 x Ø1 cm 1/50 1000
A(4)



29 03 31 60 242 114

8035 Kamut

Push button pen made of wheat fibre and ABS, with blue ink.

13,8 x Ø1 cm 50 1000
A(4)



8096 **Dante** 

ABS ball pen with push button. Body in a wide range of colours with comfortable grip. Details in black and metal. Blue ink.

 13,8 x Ø1 cm  1/50  1000

 A(4)



8099 **Citix** 

Ball pen with matching push button and tip in a two-colour finish. Blue ink.

 14 x Ø1,10 cm  1/50  1000

 A(4)

CITIX & DANTE

SAME DESIGN ANOTHER CONSCIENCE



WHEATFIBRE



8032 Hana



8008 Ontario



29 03 31 60 242 114

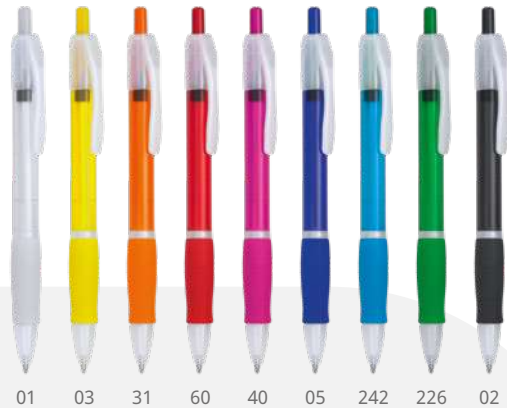

01 03 31 60 40 05 242 226 02



WHEAT FIBER

8032 Hana



Push button pen made of wheat fibre and ABS with soft grip. Blue ink.

 14,5 x Ø1 cm  1/50  1000

 A(4)

8008 Ontario

Push ball pen in translucent finish and soft matching grip. Blue ink.

 14,5 x Ø1 cm  1/50  1000

 A(4)

100% ECOFRIENDLY



8029 Grove

Retractable pen made of recycled cardboard, with tip and clip in wheat fibre and ABS. Blue ink.

 14 x Ø1 cm  50  1000
 A(4), W

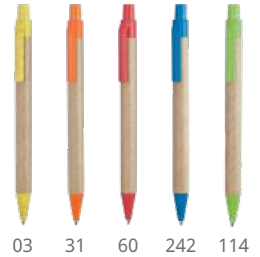

8079 Alder

Ball pen with body in recycled cardboard and PLA. Blue ink.

 13,9 x Ø0,90 cm  50  1000
 A(4), W

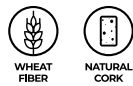

8043 Comper

Eco-line ball pen with body in cork and details in wheat fibre. Blue ink.

 14 x Ø1 cm  1/50  1000
 A(4)



8042 Liande

Ball pen with cap, made of recycled cardboard. Blue ink.

 14,2 x Ø0,80 cm  50  1000
 A(4), W



100% RPET

MADE FROM RECYCLED PLASTICS

8048 **Arashi**



03

31

49



8048 **Arashi**

2-in-1 pen/marker in semitransparent design, made from RPET material. Blue ink ball pen and fluor colour marker.

 14,6 x Ø1,30 cm  1/50  1000

 A(4)

8033 **Pacific**



00

31

60

242

05

226

02

8033 **Pacific**

Translucent design pen made from RPET material. Push button. Blue ink.

 14,2 x Ø1,10 cm  50/50  1000

 A(4)

STYLE & COLOUR



60 05 251 02

8012 **Dormitur**

Pen in ABS with twist mechanism in metallic finish. Blue ink.

 15 x Ø1,10 cm  1/50  1000

 A(4)



8012 **Dormitur**

8011 **Irati**

8006 **Semenic**



0201 0203 0231 0260 0205 02226

8011 **Irati**

Pen in ABS with twist mechanism in two-colour gloss finish. Blue ink.

 14,5 x Ø1 cm  1/50  1000

 A(4)



31 60 05 226 251 02

8006 **Semenic**

Pen in ABS with twist mechanism and touch pointer. Metallic finish. Blue ink.

 13,5 x Ø1 cm  1/50  1000

 A(4)



TOUCH PEN

MULTI COLOUR PENS



60 05 226 02

8094 **Kunoy**

Retractable 4-ink ball pen. Body in ABS with soft colour grip. Blue, black, red and green ink.

14,1 x Ø1,30 cm 1/50 1000

A(4)



60 05 251

8098 **Sandur**

Retractable 3-ink ball pen. Body in ABS with details in black and soft grip. Blue, black and red ink.

14,8 x Ø1,10 cm 1/50 500

A(4)

SPECIALFORLASER



SPECIAL LASER
ENGRAVING



01 60 05 55 226 02

8095 **Dover**

Push ball pen with soft touch metal body. Tip, clip and push button in chrome plated finish. Blue ink. Special for laser printing.

13,7 x Ø1 cm 1/50 500
B(4), L1



8014 **Borneo**

8004 **Canaima**

8005 **Baume**



01 03 60 05 226 02

8014 **Borneo**



TOUCH PEN

Metallic pen with push button. Touch pointer and design clip. Jumbo refill in blue ink.

14,8 x Ø1 cm 50 500
B(4), L1



01 03 31 60 40 05 226 02

8004 **Canaima**



TOUCH PEN

Aluminium pen with twist mechanism and touch pointer. Blue ink.

12,5 x Ø0,90 cm 1/100 1000
B(4), L1



01 03 31 60 05 226 251 02

8005 **Baume**



TOUCH PEN

Aluminium pen with twist mechanism and matching colour touch pointer. Blue ink.

13,7 x Ø0,70 cm 1/100 1000
B(4), L1



29



BAMBOO

8093 **Besky** 

Ball pen with body in bamboo and push button in metal finish. Blue ink jumbo refill.

 14 x Ø1,10 cm  1/50  1000

 B(4)



29 03 31 60 242 114



WHEAT FIBER

8030 **Hayedo** 

Push button pen made of wheat fibre and ABS with silver details. Blue ink.

 14,1 x Ø1 cm  1/50  1000

 A(4)

SAME DESIGN | DIFFERENT FINISHING TOUCHES



01 60 05 226 251 02

8013 **Ardenes** 

Ballpoint pen with aluminium body and push button in anodized finish. Jumbo refill in blue ink.

 13,7 x Ø1 cm  1/50  500

 B(4), L1

SOFT TOUCH



01 03 60 05 226 02

8078 **Norfolk** 

Ball pen with soft touch metal body and push button in anodized finish. Tip, clip and details in chrome plated metal. Jumbo refill in black ink.

 13,6 x Ø1 cm  1/50  500

 B(4), L1

METALLIC COLOURS



TOUCH PEN

8090 **Kruger**

Ball pen with aluminium body and push button in anodized finish. Touch pointer and jumbo refill in blue ink.

 13,9 x Ø1 cm  1/50  500

 B(4), L1



antibacterial
ISO 22196



TOUCH PEN

8015 **Hallerbos**

Ballpoint pen with antibacterial ABS body and touch pointer. Metal clip and jumbo blue ink refill. ISO 22196 standard compliance.

 13,9 x Ø1 cm  1/50  1000

 A(4)

+ antibacterial
ISO 22196



RECYCLED ALUMINUM
NEW
ALVIK

NEW.



7973 **Alvik** 

Elegant twist ball pen with body in recycled aluminium and metal details. Blue ink jumbo refill.

 14,2 x Ø1,10 cm  1/50  500

 B(4), L1

NEW SIMON

RECYCLED ALUMINIUM

NEW.



7972 **Simon** 

Ball pen with body in recycled aluminium and push button in anodized finish. Blue ink jumbo refill.

 14 x Ø1 cm  1/50  500
 B(4), L1

NEW ALVOR





NEW.



55 47 02

7975 **Alvor**

Pen sleeve in imitation suede.

 15,5 x 2,5 cm  10/200  6000
 B(1)



01 29 02

7995 **Burton**

Cardboard sleeve with window for pens.

 4 x 15,5 cm  50/400  4000
 B(4)

PERPETUAL PENCIL

NEW

TURIN



NEW.



251 02

7976 Turin

Pencil with aluminium body. Lead tip for endless interchangeable writing. No need to sharpen. Presentation in eco box.

 15 x Ø0,80 cm  1/50  500

 B(4), L1



NEW.



WHEAT FIBER



RECYCLED PAPER

7981 **Muret**

Perpetual pencil with cardboard and wheat fibre body. Lead tip for endless writing. No need to sharpen.

14 x Ø0,80 cm

50

1000

A(4)

PERPETUAL PENCILS



29



29



BAMBOO



7999 **Tikun**

Perpetual pencil with bamboo body. Lead tip for endless writing. No need to sharpen. Rubber included.

15 x Ø0,80 cm

1/50

1000

A(4), L1



BAMBOO

7998 **Bakan**

Perpetual pencil with bamboo body. Lead tip for endless writing. No need to sharpen.

15 x Ø0,80 cm

1/50

1000

A(4), L1



7999 **Tikun**

7998 **Bakan**





MULTI-TOOL



01 60 05 251 02

8024 **Kanchan**

4-in-1 multi-tool ball pen: level, ruler in centimeters and inches, flat screwdriver and star screwdriver. Main body in metal finish, rotating mechanism and metal clip. Blue ink.

 14,9 x Ø1 cm  1/50  1000
 B(4)



60 05 251 02

8023 **Araya**

Ball pen with LED flashlight and metallic ABS body. In-built carabiner in cap. Blue ink.

 11 x Ø1 cm  1/50  500
 B(4)

CARPENTER PENCIL

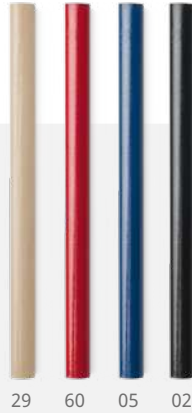

8088 Veta

Oval-shaped carpenter pencil for easy marking. Unsharpened tip.

17,6 x 1,2 cm 100 1000

A(4), L1

29 60 05 02

8003 Mata

Mini wooden pencil in natural finish with rubber. Round body.

10 x Ø0,50 cm 100 2000

A(4)



01 29 03 31 60 40 05 55 226 02

8002 Couvet

Round wooden pencil with rubber.

18,6 x Ø0,70 cm 100 2000

A(4), L1



+ antibacterial ISO 22196



01 03 31 40 60 05 226



8046 Gryfin

Wooden antibacterial pencil with rubber available in different colours.

18,6 x Ø0,70 cm 100 2000

A(4)





8049 Tilos

Drawing set for kids. Pad with drawings, 6 colour pencils and a sharpener included. Presentation in a recycled cardboard case.

7,4 x 1,5 x 9 cm 1/50 400

C(4), W

COLOUR AND FUN



8077 Pyrus

Children's drawing set. Drawing pad with 36 sheets with different drawing designs and 12 colour pencils included.

10 x 1 x 9,5 cm 1/50 200

C(4)

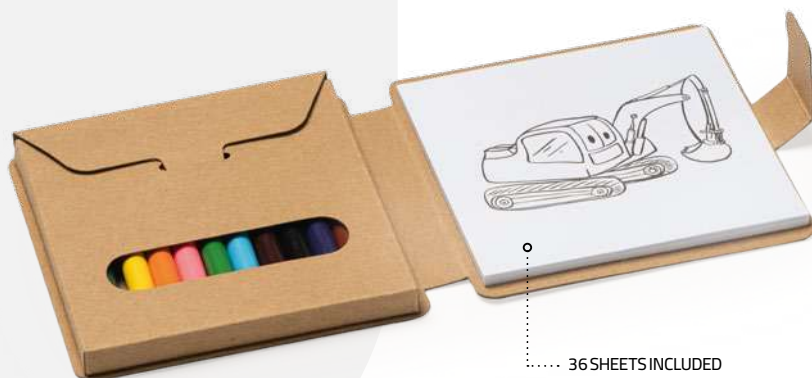

36 SHEETS INCLUDED



20 SHEETS INCLUDED



8069 Resol

Children's drawing set with practical carry handle. Drawing pad, 6 colour pencils, sharpener and rubber included.

20 x 21 x 1,6 cm 1/40 80

D(1)



NEW.



7571 Solaz

Pencil case in non-woven for kids, with design for colouring. 5 crayons in assorted colours included.

22 x 11 cm 1/50 200
 F(1)



8087 Vernak

Writing set in natural wood, presented in a cardboard case. Ruler, 3 pencils, 1 rubber and 1 sharpener included.

17,7 x 1,3 x 4,5 cm 1/20 240
 B(4), W



8064 Lizana

5-piece set presented in a kraft cardboard case, including a ball pen with cardboard body and blue ink, a wooden pencil, a sharpener, a rubber and a 15 cm ruler.

17,7 x 1,5 x 4,5 cm 1/50 400
 B(4), W

NEW YAMBI

NEW.



7989 Yambi

Thick 4-chalk set. Blue, red, green and yellow colours. Presentation in eco box.

10,5 x 9,5 x 2,5 cm

1/50

100

B(4)



8092 Waldo

13-piece drawing set. 6 crayons, 6 wooden pencils and a sharpener included. Presentation in a cardboard case.

10 x Ø4,60 cm

1/10

200

B(4), W



8000 Boreal

Set of 6 crayons in a recycled cardboard box.

5 x 8,3 x 0,8 cm

1/50

400

B(4), W



8001 Amazonia

Set of 6 wooden pencils in a recycled cardboard box.

4,5 x 9 x 0,8 cm 25/25 500

B(4), W



7996 Koel

Set of 12 wooden pencils in a recycled cardboard box.

9 x 9 cm 25 250

B(4), W



8089 Mabel

Wooden 6-pencil set in a recycled cardboard case with translucent colour cap. In-built sharpener in cap.

10,2 x Ø2,70 cm 1/50 400

B(4), W



7997 Denok

Set of 3 wooden pencils in a recycled cardboard box.

2,4 x 9 x 0,8 cm 50 1000

B(4), W

PENCIL SET

NEW.



NATURAL CORK

NEW BALOK

MULTIPURPOSE FOLDER | A4 | MAGNETIC CLOSURE



NATURAL
CORK

7985 Balok

Multipurpose A4 folder in natural cork with magnetic clasp. Detachable 30-sheet lined pad, 4 inside pockets and pen holder included.

 24,5 x 31 x 1,5 cm  1

 20

 F(1), L2

NEW.



NEW/SAMAR



255



58



02



RECYCLED
PET

7984 **Samar**

Multipurpose A4 folder in heather 600D RPET with magnetic clasp. Detachable 30-sheet lined pad included. 4 inside pockets and pen holder.

24,5 x 31 x 1,5 cm 1

20

G(1), N(8)



RECYCLED CARDBOARD

NEW.



7980 **Yasper**

Folder in recycled cardboard. Detachable 20-sheet plain pad, matching pen in wheat fibre, inside pocket and card holder included.

32 x 23 x 1,5 cm 1

50

B(1), F(1)

NEW.



7978 **Ledo**

A5 notebook. Bamboo finish hard covers with stand function. Bookmark and 80 lined sheets.

15 x 21 x 1,5 cm 1/20 40
E(1)

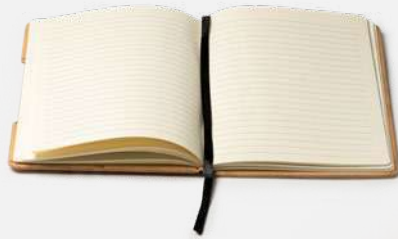

NOTEBOOKS | A5 | SUPPORTING FUNCTION

NEW.



255



58



02



7977 **Darit**

A5 notebook. RPET hard covers with stand function. Elastic band, bookmark and pen holder. 80 sheets.

15 x 21 x 1,5 cm 1/20 40
E(1)





NEW.

SIKAS
NEW

NOTEBOOK | A5 | SUPPORTING FUNCTION



RECYCLED
PET

7971 **Sikas**

A5 notebook with RPET hard covers. Pen and mobile holder included. 80 plain sheets.

14,6 x 21,4 x 1,5 cm

1/25

50

E(1), W, T

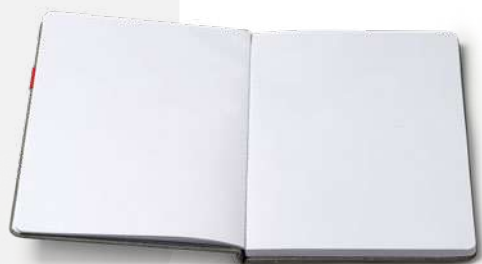



100%
RECYCLED
PET



RECYCLED
PET

7979 **Soyer**

A5 notebook with hard covers in RPET. Matching bookmark and elastic band. 80 sheets.

14,7 x 21 x 1,5 cm 1/25 50

E(1)

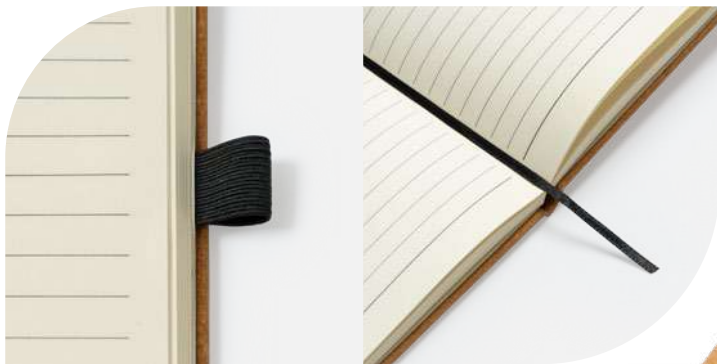

RECYCLED
LEATHER

7974 **Korum**

A5 notebook with hard covers in recycled leather. Bookmark and elastic band. 100 lined sheets.

14,5 x 21 x 1,4 cm 1/25 50

E(4), L2



100% **RECYCLED** LEATHER

SET

NOTEBOOK & PEN

WHEAT
FIBERNATURAL
CORK

COTTON

8081 **Robin** 

A5 notebook with hard covers in cork and cotton. 80 plain sheets. Cork and wheat fibre pen in matching pen holder included. Blue ink.

 15,2 x 21 x 1,4 cm  1/25  50

 E(1), B(1), N(8), L2, W

GALA



BAMBOO COVER | RECYCLED PAPER
BAMBOO BALL PEN



BAMBOO

8082 **Gala** 

A5 bamboo notebook and pen set, presented in a cardboard kraft case. Notebook with hard covers and 80 lined recycled paper sheets. Ball pen with chrome plated details and blue ink.

 22 x 24 x 2,2 cm  1/20  40

 E(1), B(1)



NEW.



7988 **Andros**

A5 notebook with hard covers in natural cork. Bookmark and elastic band. 80 sheets.

14 x 21 x 1,5 cm 1/25 50
E(4), L2



8072 **Cales**

A6 notepad with hard natural cork cover. Bookmark and elastic band. 80 sheets.

8,9 x 14 x 1,4 cm 1/50 100
E(4), L2

NATURALCORK

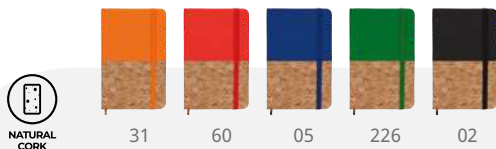

8071 **Iris**

A6 notepad with hard half cork half leatherette covers. Bookmark and elastic band. 80 sheets.

9,3 x 14,3 x 1,5 cm 1/50 100
E(4), L2



PIANA



NEW.



7987 Piana

A5 notebook with hard covers in black PU. Colour bookmark, elastic band and pen holder. 80 lined sheets.

14 x 21 x 1,5 cm 1/25 50

E(4), T

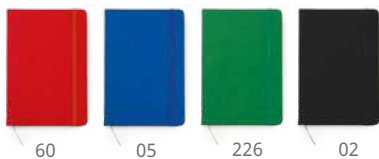

8091 Ardak

A5 notebook with imitation leather covers. Bookmark and elastic band. 100 lined sheets.

14,7 x 1,5 x 21 cm 1/25 50

E(4), T, W





8051 **Coral**

8050 **Alba**

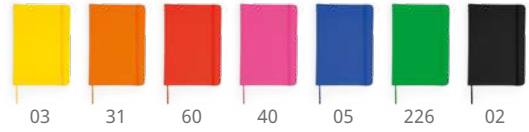

8050 **Alba**

A5 notepad with rigid leatherette cover. Bookmark and elastic band. 100 sheets.

14,7 x 21 x 1,5 cm 1/25 50
 E(4), T



8051 **Coral**

A6 notepad with rigid leatherette cover. Bookmark and elastic band. 100 sheets.

9,3 x 14,3 x 1,5 cm 1/50 100
 E(4), T

+ antibacterial
 ISO 22196

8061 **Elion**

A6 notepad with antibacterial PU covers. Bookmark and elastic band. 80 sheets. ISO 22196 standard compliance.

9 x 14 x 1,4 cm 1/50 100
 E(4)

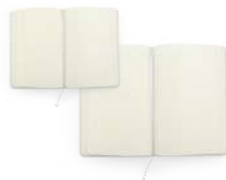

8060 **Watson**

A5 notepad with antibacterial PU covers. Bookmark and elastic band. 100 sheets. ISO 22196 standard compliance.

14,9 x 21 x 1,4 cm 1/25 50
 E(4)



8061 **Elion**

8060 **Watson**





01 03 31 60



05 226 40 02



7994 **Leynax**



Spiral ring notebook with plain sheets and pen holder. Hard covers and matching recycled cardboard pen. 70 sheets.

15 x 1,9 x 18,2 cm 1/25 50

E(1), B(4)



31 60 05 226 02



8073 **Alani**



Spiral ring notebook with recycled cardboard hardcovers. Matching pen with blue ink included. 60 sheets.

16,5 x 21 x 1 cm 1/20 80

E(4)



01 03 60 05 226 02



8070 **Estela**

A5 notepad with hard covers in recycled cardboard. Bookmark and colour elastic band. 100 sheets.

14,7 x 21 x 1,5 cm 1/25 50

E(4)



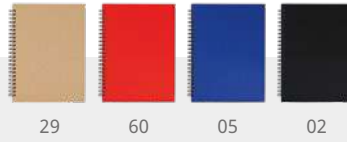
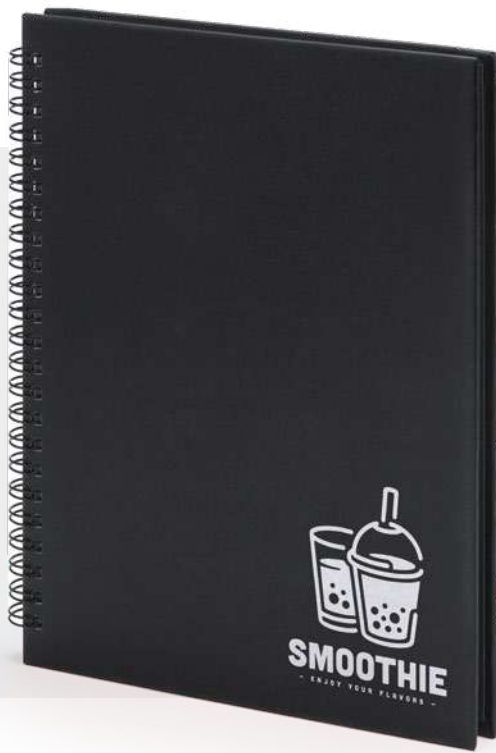

29 60 05 02



8052 **Valle**

Spiral ring notebook with microperforated lined sheets. Hard covers in recycled cardboard. 80 sheets.

16,4 x 21,7 x 1,6 cm

1/25 50

E(4)

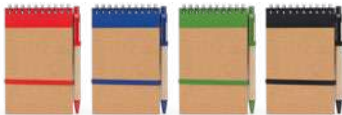

60 05 226 02



8074 **Lien**

Spiral ring notebook with recycled cardboard hardcover. Includes matching pen with blue ink. 70 sheets.

9,7 x 14,4 x 1 cm 1/50 100

D(4), B(4)



01 31 60 05 02

8054 **Arco**

Spring mini notebook with rigid PP cover. 60 sheets of striped paper. Includes pen with blue ink.

7 x 9,5 x 0,7 cm 1/50 300

D(4), B(4)



NEW.
COLORS

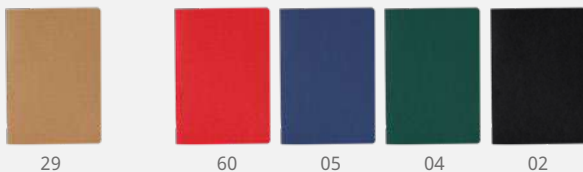

RECYCLED PAPER

8053 **Danica**

A5 notebook in recycled paper. 60 lined sheets.

14,5 x 21 x 0,8 cm 1/10 100

E(1)



RECYCLED PAPER

8055 **Saler**

A6 notebook made of recycled cardboard. 60 sheets.

10,5 x 14,5 x 0,8 cm 1/20 200

E(1)



BIODEGRADABLE PAPER COVERS

RECYCLED | DEGRADABLE | GROWING



RECYCLED
PAPER

8086 Sagra

A6 notebook with recycled and biodegradable paper covers with seeds. 40 lined sheets. Presentation in a kraft paper sleeve.

10,7 x 15 x 0,7 cm 1/100 200

E(1)



RECYCLED
PAPER

8085 Garo

Notepad with recycled and biodegradable paper covers with seeds. 50 notes in recycled paper included.

7,2 x 10 x 0,8 cm 100 200

C(1)



RECYCLED
PAPER

8063 Bosco

Classic note pad with recycled cardboard covers. 200 white sheets and 125 sticky note strips in different colours included.

8,1 x 2,6 x 8,3 cm 1/50 100

D(2), W



8056 Innis

Original and practical recycled cardboard notepad, with 100 sticky note strips in 5 assorted colours.

5,4 x 8,2 cm

1/100 500

C(4)



01



29

8062 Dimas

Cardboard desk set in the shape of a cube, formed by a pencil holder, note pad (250 sheets) and 180 adhesive notes in different colours.

9 x 9 x 9 cm

1

40

D(2), W



8057 Anfi

Sticky notes spiral ring pad with original design in the shape of a speech bubble. Hard recycled cardboard covers. Includes sticky notes in assorted colours in two sizes: 100 large and 125 small.

8,3 x 10,7 x 2,3 cm

1/50

100

D(4)



NATURAL CORK



7546 **Vespula**

Natural cork case with polyester inner lining and zip.

23 x 11 x 2 cm 1/50 200

E(1), L2

NATURALCORK

CASES



01

03

31



60

05

226

02

7559 **Colina**

Plain colour pencil case with matching zipper, made of 600D polyester.

22 x 11 cm 1/20 400

E(1), N(8), O

CALENDARS 2024



8066 Flint

Horizontal spiral ring table calendar. Layout: actual month / previous month / following month / yearly calendar. Saints' days included. Cardboard stand ideal for printing.

22 x 13,8 x 6 cm 50 200
 E(4)

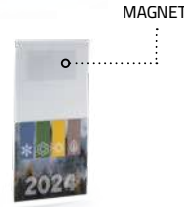

8067 Glen

Magnet calendar with easy-to-rip sheets. Actual month layout. Wide space for printing.

10 x 19 cm 25 400
 C(1)



8065 Dean

Vertical spiral ring table calendar. Layout: actual month / previous month / following month / yearly calendar. Saints' days included. Cardboard stand ideal for printing.

10,8 x 13,8 x 6 cm 50 400
 E(4)



8068 Hera

A5 spiral ring diary. Padded PU covers engraved in low relief. 352 sheets. Day/page layout with die-cut corners.

15,8 x 21 x 2,4 cm 1 20
 E(1), T, U

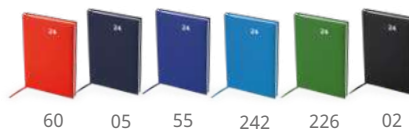

8059 Horus

A5 diary with padded PU cover engraved in low relief. 320 pages plus 4 pages with maps. Bookmark matching the front cover.

15 x 21 cm 1 20
 E(1), T, U



8083 Selkis

Diary with padded imitation leather covers engraved in low relief. 320 beige sheets plus 4 pages with maps. Bookmark matching the covers. Presentation in white box.

17,6 x 24,5 x 2,1 cm 1 20
 E(1), T, U



8020 **Fenix**

Perpetual table calendar made of PP, with enough space for pad printing marking.

14 x 4 cm

1/50

300

D(2)



BAMBOO

1002 **Medus**

Perpetual table calendar made of bamboo, formed of one stand and four engraved blocks. Presentation in eco box.

13,6 x 4,6 x 5 cm 1/20 100

D(1), L2



01



60



05



226

3017 **Serbal**

Mouse pad with 2024 calendar. Transparent PVC cover. Easy-to-rip sheets with space for notes. Non-slip base.

23 x 18 x 0,4 cm

1/50

100

E(4)

BAGS & TRAVEL

NEW VOLANO



05

47

02



CABIN SIZE

7186 Volano **NEW.**

Rigid trolley suitcase in resistant ABS. Two main compartments and interior mesh pocket. In-built safety lock included.

34 x 51 x 20 cm

1

2

K(1), L2



CABIN SIZE



BLEIK



55



47



02

7187 **Bleik**

Rigid trolley suitcase in resistant ABS. Two main compartments and interior mesh pocket. In-built TSA safety lock included.

 35 x 55 x 23 cm



1



1

 K(1), L2



NEW.





02



05



7178 **Garnes**

Wheel trolley backpack made of 300D heather polyester. Main roomy pocket with inner padded compartment, ideal for laptops up to 15". Two pockets with interior compartments and a front pocket. High quality and resistant frame. Adjustable padded shoulder straps. Stain-resistant wheel covers.

33,5 x 51 x 21 cm 1 4

1(8)



BACKPACK

GARNES



NEW WARKA

NEW.



7083 **Warka**

Executive travel backpack in 300D polyester. Two main padded pockets with interior compartments and perfect pockets for laptops or tablets. Padded back and shoulder straps. Strap concealing pocket and trolley strap.

 32 x 41 x 14 cm



1



10

 G(1), N(8), O, P



RECYCLED PET

7500 **Kalmar**

Padded document case for your laptop made from 600D RPET recycled polyester in heather finish. Two compartments with waterproof zip. Matching handles and adjusting shoulder strap. Trolley strap included.

37 x 5 x 28 cm

1

30

F(1), N(8)



RECYCLED PET

05

58

02

7139 **Gregor**

RPET 600D polyester backpack in heather finish. Main padded pocket, ideal for your laptop or tablet. In-built USB port to connect your power bank (not included). Front and side pockets. Padded shoulder straps and back.

29 x 43 x 13 cm

1

20

F(1), N(8), O, P



RECYCLED PET

7566 **Kebal**

58

05

Padded case for 15" laptops made of RPET 300D polyester.

39,5 x 29 x 3,5 cm

1

30

F(1), N(8)



RECYCLED PET



58

255



7106 **Malmo**

Backpack made from 600D RPET recycled polyester with heather finish. Padded body and interior pocket, ideal for your laptop. Double compartment with waterproof zip and exterior pocket. Padded shoulder straps and trolley strap.



31 x 42 x 12 cm  1  20

 G(1), N(8)



7176 **Sidney**

600D RPET polyester backpack in heather design. Padded body and interior pockets for laptops and tablets. Double compartment and side pockets. Padded shoulder straps.

31 x 45 x 13 cm  1  20

 G(1), N(8)





02

58



NARVIK



7177 **Narvik**

Backpack made of 300D polyester. Innovative design in an OXFORD finish. Main padded pocket, ideal for your laptop, and two front pockets with elegant pullers. In-built USB port included to connect your power bank (not included). Padded back and shoulder straps.

31 x 43 x 16 cm 1 20

N(8), G(1)



ORMOK

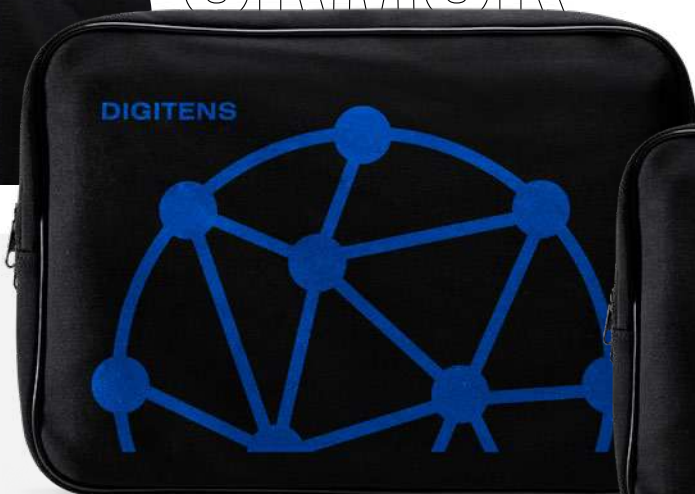

DEXTER



7568 **Ormok**

Padded case for 15'' laptops made of high density foam.

39 x 26,5 x 3,5 cm 1 25

F(1), N(8)



7567 **Dexter**

Padded case for 13'' laptops made of high density foam.

34 x 24 x 3 cm 1 25

F(1), N(8)

ANTI-THEFT

7172 **Moana**

Nylon anti-theft backpack. Compartment with USB port to connect power banks (not included). Micro USB cable included. Multifunctional pocket in right strap. Main pocket with two padded compartments for laptops and tablets. Padded back and shoulder straps.

30 x 44 x 16 cm  1  10

 G(1), N(8)



55

02

7171 Duke

Nylon backpack. Padded interior pocket for laptops. Padded back and shoulder straps. Compartment with USB port to connect power banks (not included). Micro USB cable included.

30 x 45 x 20 cm



1



10

G(1), N(8)



02

58

55



7173 Mardok

600D nylon backpack with padded back and shoulder straps. Padded interior compartment for laptops.

32,5 x 44 x 25 cm 1

10

G(1), N(8)



58

243

255



7146 Chucao

Polyester laptop backpack in a heather finish design. Padded shoulder straps, back and handles. Double front compartment and side pockets. Removable label.

28 x 43 x 13 cm 1

15

Consult





29

31

05

226

02

60



7515 **Lora**

Padded document bag for your laptop in soft 600D polyester with exterior pocket. Matching carry handles and adjustable shoulder strap with carabiner.

40,5 x 30 x 5,5 cm 1 50

F(1), N(8)



POLYESTER 900D



231

60

55

15

7138 **Dodo**

Multifunctional backpack in 900D polyester. Roll top roomy main compartment with zip and snap fasteners. Side pockets. Padded back and shoulder straps. Removable label.

44 x 30 x 10 cm 1 10

Consult

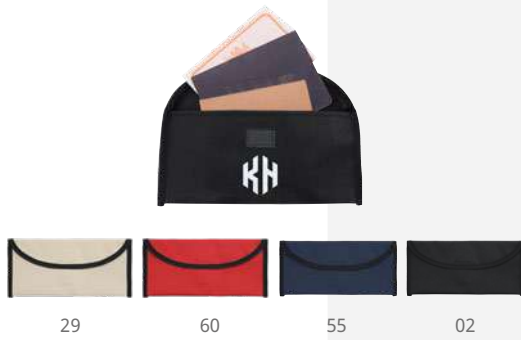

7518 **Garza**

Travel document bag with velcro fastening and practical belt loop. 600D polyester.

27 x 13 cm 1/40 400
E(1), N(8)



7517 **Charran**

Document bag in 600D polyester in different colours with carry handle and matching zipper.

40 x 29,5 x 5,5 cm 1/20 100
F(1), N(8)



7516 **Libe**

Document bag in 600D polyester with main compartment and zip fastening. Reinforced edging and carry handle integrated in the design.

38 x 32 cm 1/20 100
F(1), N(8)





NEW.

2991 **Covas**

Personal alarm, activated by separating the connector attached to the keyring. Presentation in design box.

3,9 x 6,1 x 1,9 cm 1/50 300

D(4)



ENJOY YOUR TRIP



3014 **Gordon**

Universal travel adapter for Europe, Asia, USA, Australia. Presentation in white box.

8,2 x Ø4,50 cm 1/50 100

D(4)



LED INDICATOR



3013 **Bopp**

Universal travel adapter with compact and retractable design, in matt finish and soft touch. Europe, Asia, United Kingdom, USA, Australia. 2 USB ports 2.100 mAh charging speed. Presentation in white box.

6,1 x 5,6 x 4,5 cm 1/50 100

D(1), W



01

02



55

258

02

8201 Ansar

Inflatable pillow ideal for traveling with soft suede touch.

33 x 9 x 25 cm 1/20 200

F(1)



8200 Branta

Travel mask made of soft microfiber. Double elastic adjustment.

18,5 x 9 cm 1/100 1000

D(1), N(8)

TIME TO
RELAX



03

60

40

05

226

8199 Noys

Earplugs in EVA foam. Presentation in a case with carry chain.

6,4 x Ø2,20 cm 1/200 1000

C(1)

NEW.



01

02

8151 Yllier

Unisex hotel slippers in comfortable cotton/polyester with padded lining. Practical non-woven pouch included. One size (36 to 43).

11,5 x 29 x 1,7 cm 1/10 200

E(1), N(8)



NATURAL
CORK



1126 Podox

Manicure kit with cork case and snap fastener. Stainless steel scissors, tweezers, nail clippers, file and cuticle trimmer included.

11 x 6 x 2 cm

1/50

200

E(1), L1, N(8)

NEW.



NEW.

1125 Velvet

Manicure kit in a drawstring cotton pouch. Nail file and clipper included.

12 x 7,8 cm

1/50

400

F(1), L1, N(8)



NEW.

8311 Chelsy

Shoe cleaning kit including a shoehorn, a cleaning cloth, 2 brushes and a neutral polish. Presentation in a metal box.

14 x 4,7 x 10 cm

1

80

G(1), L2





8206 **Petra**

Cork suitcase tag. Inner card included.

6 x 11,7 cm 50/100 500

D(1), L1



9935 **Arnold**

Resealable travel bag in transparent PVC. Assortment of practical bottles for gel, shampoo and perfume included.

19 x 19 cm 1 100

F(1)



NEW.



8204 **Charter**

Suitcase tag in the shape of a trolley. Inner card included.

5,5 x 9,5 x 0,4 cm 1/50 500

C(4)



BACKPOCKET



7548 **Vultur**

600D polyester belt pouch with two compartments, on the front and back. Matching zips and pullers. Adjusting strap.

25 x 17 x 8 cm 1/20 100
F(1), N(8)

NEW CAMBRAI

NEW.



7573 **Cambrai**

210D RPET belt pouch with main compartment and zip fastening.

38 x 12 x 13 cm 25 200
E(1), N(8), O





7544 **Adal**

Purse with 2 pockets and matching zips, made from soft RPET imitation leather.

10,5 x 9 cm 1/10 500
D(1), L1

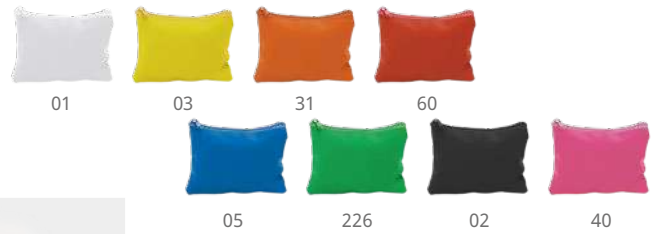

7542 **Medea**

Purse made of soft imitation leather with matching zip. Inner keyring included.

10,5 x 7,5 cm 1/20 1000
D(1), L1



7545 **Limosa**

Natural cork purse with zip and lining. Key ring included.

11 x 9 cm 1/100 800
D(1), L2



NEW.



7570 **Mauve**

PU purse in a glossy finish design, with matching zip and puller.

12 x 8,5 cm 1/10 1000
D(1)

NEW.



7497 **Naro**

Multifunctional toilet bag in 100% Fairtrade cotton (180 gsm).
Main pocket with matching zip and puller.

21 x 13 x 8 cm 10 100
F(4), N(8), O, P

FAIRTRADE COTTON

NATURAL HEMP



261



152



02



7499 **Prado**

Multifunctional toilet bag in hemp fabric (200 gsm),
with matching puller.

21 x 13 x 8 cm 1/10 100
F(1), N(8)

NEW.





RECYCLED COTTON



29 60 05 226 02



7562 Remo

Multipurpose toilet bag in recycled cotton with matching zip and puller.

21 x 12 x 3 cm 1/50 300

F(1), N(8), O

100% ORGANIC COTTON



60 05

226 29 02

7536 Delphis

100% organic cotton toilet bag with matching puller. 180 gsm.

21 x 16 cm 1/50 300

F(1), N(8), O

NEW.



7498 Zigari

Multifunctional toilet bag in 100% Fairtrade cotton (180 gsm). Main pocket with matching zip and puller.

23 x 17 x 6 cm 50 300

F(4), N(8), O, P

JUTE & COTTON



7563 Vera

Toilet bag in cotton and laminated jute.
Zip with matching jute puller.

 20 x 15 x 6 cm  1/50  200

 F(1), N(8)

7564 Siena

Toilet bag in cotton and laminated jute.
Zip with matching jute puller.

 21 x 11 x 6 cm  1/50  200

 F(1), N(8)

100% NATURAL



7560 Tyto

Toilet bag made of natural jute with matching
zip and jute puller.

 22 x 14 x 6,5 cm  10  200

 F(1)



7558 **Sierra**

Multi-purpose toilet bag made of a 180 gsm cotton and jute, with zipper and matching jute puller.

21,5 x 16 x 5 cm 10 200

F(1), N(8)

JUTE BAGS



2929

2960



2905

29226

2902



7537 **Doel**

Multipurpose 280 gsm cotton toilet bag in a two-colour design. Zipper with matching cotton puller.

22,5 x 17 x 5,5 cm 1/50 300

F(1), N(8)



SUBLIMATION



COTTON TOUCH

7569 **Osak**

Toilet bag, ideal for sublimation in soft polyester with inner lining. Zip with matching puller.

22 x 14 x 6,5 cm 1/25 500

F(1), N(8), R

COSMETIC BAGS



01 60 05 226 02



7547 **Bubo**

Toilet bag with two zip compartments and matching carry strap, made from 210D RPET recycled polyester.

21 x 13 x 8 cm 1/20 100

F(1), N(8), O





29 31 60 05 02 40

7565 **Sedna**

Multifunctional toilet bag in 600D polyester. Zip fastening with matching puller.

22 x 14 x 6 cm 1/20 300

F(1), N(8), O



29 31 60 55 05 56 02

7513 **Pardela**

Toilet bag in 600D polyester with zip and practical carry handle.

20 x 10 x 8 cm 1/10 200

F(1), N(8), O



29 31 60 05 02 40

7514 **Yubarta**

Toilet bag in 600D polyester with zip and puller in matching colour.

22 x 14 x 6 cm 10 300

F(1), N(8), O



01 03 31



60 05 226 40

7511 **Caribu**

Toilet bag in transparent PVC with air-tight seal.

17 x 13 x 5 cm 1/50 400

F(1)



05



255



02



RECYCLED
PET

7198 **Balmor** **NEW.**

Multifunctional bag made from 300D RPET in a heather finish design. 30 litres capacity. Zip fastening in main and front pocket. Side mesh pocket. Adjustable shoulder strap included.

50 x 28 x 24 cm 1 20

G(1), N(8), O, P



NEW BAL MOR



PROTECT
YOUR STUFF



60



55



02

7170 **Novak**

Roomy multifunctional bag in 600D polyester. 5 compartments with zip fastening. Reinforced base. Padded adjustable shoulder strap included.

65 x 33 x 34 cm 1 20

G(1), N(8)

MONDELO



NEW.



7616 **MondeLO**

Multifunction duffel bag made of 320 gsm recycled cotton in a heather finish design. 24 L capacity. Zip fastening in main pocket. Comfortable adjustable shoulder strap.

49 x 24 x 26 cm 1 30

F(4), N(8), O, P



60

05

226



29

02

NEW.



29

60

05

226

02



7179 **Firenza**

Backpack made of 320 gsm recycled cotton in a heather finish design. Front pocket and padded shoulder straps.

43 x 34 x 9 cm 1/10 30

F(4), N(8), O, P



FIRENZA



60

05

55

02

7115 **Falco**

Two-colour sports backpack in 900D polyester with quilted shoe compartment. One main pocket with double puller and an exterior front pocket. 30 litres capacity.

32 x 46 x 20 cm

1

10

Consult



60

05

55

02

7120 **Columba**

Sports backpack in 900D polyester with front shoe compartment. One main pocket with double puller and an exterior front pocket. 38 litres capacity.

32 x 42 x 28 cm

1

10

Consult



7182 **Oblak**

Shoe bag in 600D polyester. Practical carry handle included.

35 x 15 x 16 cm 1/25 100

F(1), N(8), O

NEW.



ENJOY YOUR TRAVEL



60

05

55

02

7121 **Canary**

Sports bag with double handle and a long adjustable carry strap. Main pocket with double puller. Shoe pocket with removable compartment. Damp-proof. Hard bottom. Easy cleaning. 53 litres capacity.

48 x 42 x 26 cm 1 10

Consult

NEW OTAWA

NEW.



60

05

226

02

7183 **Otawa**

Sports backpack in high-resistance 210D ripstop nylon. 30 litres capacity. Double main compartment with zip fastening and interior pockets. Front elastic bungee cord compartment and side mesh pockets. Padded back and shoulder straps. Adjustable side strap included.

 32 x 47 x 20 cm

 1

 20

 G(1), N(8)





7181 **Misuri**

Sports backpack in 600D polyester. Zip fastening in main and front pocket. Front elastic bungee cord and side mesh pockets. Padded back and shoulder straps.

30 x 45 x 14 cm 1 40

F(1), N(8)



7153 **Condor**

Backpack in 600D polyester with zip fastening. Front pocket with cable eyelet. Side pockets in microperforated design. Removable label.

30 x 40 x 18 cm 1 40

F(1), N(8), O



7154 **Sison**

Compact and light backpack in resistant 600D polyester. Front pocket with vertical opening. Padded back and shoulder straps. Removable label.

23 x 40 x 12 cm 1 50

F(1), N(8), O, R





03 31 60 55 05



12 226 15 78 02



256 248 246



135 243 252

DAILY BAGS

7124 Marabu

Classic backpack in 900D polyester with roomy compartments. Padded back and shoulder straps. Removable label.

30 x 40 x 18 cm 1 20

Consult

7145 Teros

Classic 300D polyester backpack in a heather finish design. Front pocket with cable eyelet. Padded back and shoulder straps. Details in black. Removable label.

30 x 40 x 12 cm 1 20

Consult

BACKPACKS



7174 **Wilde**

600D polyester backpack with two main compartments and a front pocket. One side mesh pocket. Padded back and shoulder straps.

31 x 41 x 16 cm 1 40
F(1), N(8), O, P

7158 **Tucan**

Classic backpack in resistant 600D polyester, with main compartment and front pocket. Zip with puller for easy fastening. Padded back and shoulder straps. Removable label.

28 x 38 x 12 cm 1 50
F(1), N(8), O, P



226

60

05

02



7087 **Brest**

Drawstring bag in 100% organic cotton (140 gsm), with strings in natural colour.

37 x 41 cm

50

200

F(4), N(8), P, O

NEW.



ORGANIC COTTON

NEW BARONE



NEW.



7085 **Barone**

Drawstring bag in 100% Fairtrade cotton (180 gsm), with matching strings.

38 x 42 cm

50

150

F(4), N(8), O, P



ORGANIC COTTON



7098 **Muna**

Drawstring backpack made of 100% organic cotton.

38 x 42 cm

20

100

F(6), N(8), O, P



NEW.



60

55

02



7091 **Luanda**

Drawstring bag made of recycled cotton in a heather finish design and 120 gsm natural cotton. Strings in natural colour.

38 x 42 cm

20

100

F(1), N(8), O, P

NEW LUANDA



29

60

05

226

02



7165 **Brescia**

Drawstring bag made of 120 gsm recycled cotton in heather finish and cords in natural colour.

38 x 42 cm

50

100

F(4), N(8), O, P



29

60

05

226

02



7107 **Varese**

Drawstring backpack bag made of 100% recycled cotton in mottled finish, with 70 cm long matching handles and strings in natural colour. 140 gsm.

38 x 42 cm

20

100

F(6), N(8), O, P

NATURAL HEMP

NEW.



200 gsm



261



152



02

7090 **Naska**

Drawstring bag in hemp fabric (200 gsm), with matching strings.

38 x 42 cm

10

100

F(1), N(8)



01



31



60



05



226



02

105 gsm

7175 **Adare**

100% cotton drawstring backpack with matching cords.

37 x 41 cm

10

100

F(6), N(8), M, O, P



120 gsm

7557 **Wilkes**

Drawstring backpack made of 120 gsm cotton and jute.

34 x 43 cm

10

100

F(6), N(8), O, P



140 gsm

7137 **Mirlo**

100% cotton drawstring bag with 8 mm thick cords. 140 gsm. Removable label.

34 x 42 cm

10

200

F(6), N(8), O, P

NEW.**7084 Bremen**

Multicolour drawstring bag in 210D polyester.

36 x 42 cm

50

200

F(1), N(8)

COTTON TOUCH

**7180 Kanda**

Drawstring backpack, ideal for sublimation in soft resistant polyester.

34 x 42 cm

10

100

F(1), N(8), R

NEW LABUR

HIGH VISIBILITY BACKPACK

**NEW.**

221



223



60



05

7184 Labur

Drawstring bag with high-visibility strip, in 210D polyester.

34,5 x 41 cm

10

300

F(1), N(8)



7157 **Zorzal**

Sports drawstring bag in a plain design for easy customization. Matching flat strings. Interior pocket with zip. 100% 600D polyester. 150 gsm.

35,5 x 42,5 cm 10 200
 F(1), N(8), O, P



7150 **Cuanca**

Drawstring bag in 210D polyester with metal eyelets. Front pocket in microperforated design with zip fastening and cable eyelet. Removable label.

34 x 43 cm 10 200
 F(1), N(8)



7152 **Ninfa**

Drawstring bag in 210D polyester with reinforced corners. Front pocket with zip and cable eyelet. Removable label.

34,5 x 45 cm 10 200
 F(1), N(8), R



7155 **Kagu**

Drawstring bag in 210T polyester with matching 8 mm thick cords. Removable label.

35 x 45 cm 10 200
 F(1), N(8), R



7550 **Larus**

Drawstring backpack made from soft 210D recycled polyester with reinforced corners.

34 x 42 cm 50 300
 F(1), R



7114 **Hamelin**

Drawstring bag in 210D polyester with metal eyelets. Removable label.

34 x 42 cm 50 300
 F(1), N(8), R



991



992



993

7526 **Milano**

Drawstring backpack in 190T polyester in assorted sports designs.

43,5 x 43 cm

50

300

F(1), N(8)



01

03

31

60



05

226

02

78

7151 **Calao**

80 gsm non-woven drawstring bag with metal eyelets. Removable label.

36 x 42 cm

10

300

F(1)



995



996



997



998

7528 **Elanio**

Foldable drawstring bag in 190T polyester for children. Folding pouch in different animal designs.

26,5 x 32,5 cm

10

500

F(1), G(1)



9131 Pachu

Non-woven apron with colouring design for children. 5 crayons in assorted colours included. Adjustable one size.

43 x 43 cm 1/50 200

F(1)



7530 Turcaz

Non-woven drawstring backpack with design for colouring. 5 crayons in assorted colours included.

25 x 30 cm 1/50 200

G(1)



7529 Azor

Non-woven bag with design for colouring. 5 crayons in assorted colours included.

20,5 x 22 cm 1/50 100

F(1)



NEW.

7571 Solaz

Pencil case in non-woven for kids, with design for colouring. 5 crayons in assorted colours included.

22 x 11 cm 1/50 200

F(1)

NEW SOLAZ





NEW.



03 60 05 226 02

7197 **Lubin**

Foldable cooler bag in 190T polyester. Isothermal aluminium lining and zip fastening. Reinforced handles. Easy folding with zip.

45 x 36 x 9 cm 1/20 100

G(1)



10 05 47

NEW.



7088 **Sakra**

Cooler backpack in 210D ripstop polyester. Isothermal lining in main and front pockets. Front elastic bungee cord compartment and side mesh pockets. 20 litres capacity. Padded back and shoulder straps.

26 x 40 x 19 cm 1 10

G(1), N(8)





255

243

7608 **Bismar**

Cooler bag made of RPET polyester in a heather design. Isothermic lining and front pocket. Adjustable carry strap included.

25 x 15,5 x 15,5 cm



F(1), N(8)



255

243

7609 **Marlox**

XL cooler bag made of RPET polyester in a heather design. Double compartment and front pocket. Isothermic lining. Adjustable carry strap included.

30 x 25 x 20 cm



F(1), N(8)



NEW.



55

02



7089 **Lombok**

Cooler backpack in RPET. Isothermal lining in main compartment and pocket in flap. Side mesh pockets. 19 litres capacity. Padded back and shoulder straps.

30 x 43 x 15 cm



G(1), N(8)





60



05



02

7605 Grulla

Multipurpose cooler bag in 600D polyester. Isothermic interior compartments and practical exterior pockets. Adjustable and padded shoulder strap with carabiner.

25 x 24 x 15 cm 1 20

G(1), N(8)

NEW BAYONA

NEW.



60



05



226



02

7086 Bayona

Multifunctional cooler bag in 600D polyester. Isothermal main pocket and practical front one. Adjustable carry strap included.

26 x 34 x 19 cm 1 20

G(1), N(8)





05 226 02 40 01 03 31 60

7604 Graja

Cooler drawstring bag with isothermal aluminium lining. Shell in 210D polyester.

 32 x 42 cm

 1/10

 200

 G(1), N(8)

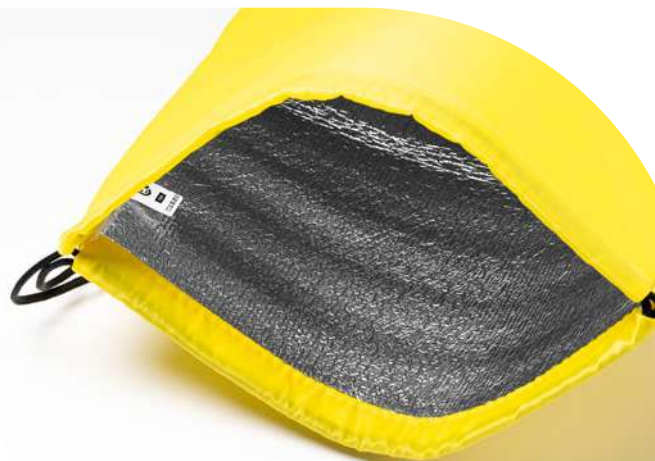

TIBU



01 31 60 05 226

7603 Tibu

Cool bag with lining in isothermal aluminum for 6 cans. Resistant PVC exterior. Matching carry handle and zip fastening.

 21 x 15 x 15 cm

 1/25

 200

 F(1), N(8)



7607 **Milana**

Classic cooler bag made of laminated paper with isothermal aluminium lining and flap with zip fastening. Practical carry handle included.

19 x 13,5 x 14 cm 25 100
F(1)



7606 **Serreta**

Cooler bag made of laminated paper with aluminium isothermic lining. Flap with velcro seal and practical colour handle.

20 x 25 x 10 cm 10/50 100
F(1)



7600 **Kemer**

Cooler bag in laminated paper with isothermic aluminium lining. Flap and exterior pocket with velcro seal.

19 x 32 x 12 cm 25 100
F(1)

4130 Buren

Sandwich bag in resistant laminated paper with zip fastening. Aluminium isothermic inner lining. Practical carry handle included.

21 x 8 x 7,5 cm 1/25 200

F(1)



01 03 60 05 226 02

4131 Rigax

Sandwich bag in colour PVC with zip fastening. Aluminium isothermic inner lining. Practical carry handle included.

21 x 8 x 7,5 cm 1/20 200

E(1), N(8)



01 60 05 226



RECYCLED PET

7599 Lombas

Reusable sandwich pouch in RPET polyester with PEVA isothermic inner lining. Velcro fastening. Easy to clean.

18 x 18 cm 1/25 500

F(1)

NEW.



NEW.



7195 **Kimex**

Colour tote bag in 100% Fairtrade cotton (180 gsm), with reinforced 70 cm long handles.

38 x 42 cm 10 100
 F(4), N(8), O, P

FAIRTRADE BAGS

NEW.



7194 **Valmir**

Tote bag in 100% Fairtrade cotton (180 gsm), with reinforced 70 cm long handles.

38 x 42 cm 50 150
 F(4), N(8), O, P





NEW.



261

152

02



HEMP

200
gsm7191 **Serpa**

Tote bag in hemp fabric (200 gsm). Reinforced 70 cm long handles.

38 x 42 cm

10

100

F(1), N(8)

HEMP HEMP

NEW.



261

152

02



HEMP

200
gsm7190 **Mafil**

Bag with gusset in hemp fabric (200 gsm). Reinforced 70 cm long handles.

38 x 42 x 10 cm

10

100

F(1), N(8)





7167 **Greta**

100% organic cotton bag with practical 70 cm long handles. 300 gsm.

40 x 40 cm 10 100
F(4), N(8), O, P

ORGANIC COTTON



7168 **Kensal**

100% organic cotton bag with gusset and practical 70 cm long handles. 280 gsm.

38 x 42 x 9 cm 10 100
F(4), N(8), O, P



7159 **Narbona**

100% organic cotton bag with gusset and reinforced 35 cm short handles. 120 gsm.

40 x 40 x 10 cm 20 200
F(4), N(8), O, P

NEW.



163

261

262

264

ORGANIC
COTTON140
gsm7193 **Bondy**

Tote bag in 100% organic cotton (140 gsm), with reinforced 70 cm long handles.

38 x 42 cm

50

200

F(4), N(8), P, O

NATURAL BAGS

ORGANIC
COTTON120
gsm7156 **Berna**

100% organic cotton bag with reinforced 70 cm long handles. 120 gsm.

38 x 42 cm

50

200

F(4),N(8),O,P



29 60 05 226 02

7162 Rivoli

100% recycled cotton bag in heather finish with 70 cm long handles. 120 gsm.

38 x 42 cm 50 200

F(4), N(8), O, P



29 60 05 226 02

7617 Lumia

Bag made of 140 gsm recycled cotton in a heather finish design, with 70 cm long handles.

38 x 41 x 8,5 cm 1/50 200

F(4), N(8)



29 60 05 226 02

7107 Varese

Drawstring backpack bag made of 100% recycled cotton in mottled finish, with 70 cm long matching handles and strings in natural colour. 140 gsm.

38 x 42 cm 20 100

F(6), N(8), O, P



60

05

02

NEW.**7189 Inca**

Recycled cotton bag in a heather finish design and 120 gsm natural cotton with gusset. Reinforced 70 cm long handles.

 38 x 41 x 8 cm

 20

 100

 F(1), N(8), O, P

RECYCLED COTTON

NEW.

60

05

02

7188 Palmira

Recycled cotton bag in a heather finish design and 120 gsm natural cotton. Reinforced 70 cm long handles.

 38 x 42 cm

 20

 200

 F(1), N(8), O, P

100% NATURAL COTTON

SAME DESIGN | DIFFERENT WEIGHT

105
gsm

7520 **Hillock**

Sewn shopping bag in 100% cotton with practical 70 cm long reinforced handles. 105 gsm.

 37 x 41 cm

 50

 250

 F(4), N(8), O, P

140
gsm

7601 **Hill**

Shopping bag in 100% cotton with 70 cm long handles. 140 gsm.

 37 x 41 cm

 20

 200

 F(4), N(8), O, P

180
gsm

7551 **Zenith**

Sewn shopping bag made of 100% cotton with practical reinforced 70 cm long handles. 180 gsm.

 37 x 41 cm

 50

 150

 F(4), N(8), P

PUPPYPAWS
YOUR ONLY ONE STOP PET STORE

100% NATURAL COTTON

NEW.



7521 **Knoll**

7160 **Niza**

7602 **Mountain**

7196 **Berlin**



03 60 05 226 02

7160 **Niza**

105
gsm

100% 105 gsm cotton bag with 70 cm long colour handles.

37 x 41 cm

50

200

F(4), N(8), O, P



NEW.

119

7196 **Berlin**

180
gsm

Multicolour tote bag in 100% cotton (180 gsm), with reinforced 70 cm long handles.

38 x 42 cm

50

150

F(1), N(8), O, P



01 03 31 60



40 05 226 02

7521 **Knoll**

105
gsm

Shopping bag in stitched 100% 105 gsm colour cotton, with practical 70 cm reinforced long handles.

37 x 41 cm

50

250

F(4), N(8), O, P



01 03 31 60 40 05 226 02



48 63 55 242

NEW.
COLORS

7602 **Mountain**

140
gsm

Shopping bag made of 100% 140 gsm cotton in different colours, with 70 cm long handles.

37 x 41 cm

20

200

F(4), N(8), O, P



105 gsm

7519 Baguette

Bag in sewn 100% 105 gsm cotton with classic bread format. Thick drawstring fastening.

20 x 58 cm 10 500
F(1), N(8), O, P

100% COTTON



105 gsm

7525 Dune

Foldable shopping bag made of 100% 105 gsm cotton, with 70 cm long handles and adjustable folding drawstring pouch.

37 x 41 cm 10 200
F(4), G(4), N(8), P



180 gsm

7553 Leaf

Shopping bag made of 180 gsm cotton in plain and mesh design, with 60 cm reinforced handles.

45 x 42 cm 10 100
F(4), N(8)



120 gsm

7615 **Zapax**

Drawstring bag in 120 gsm cotton. Perfect for shoe storage.

42 x 34 cm

50

200

F(4), N(8)

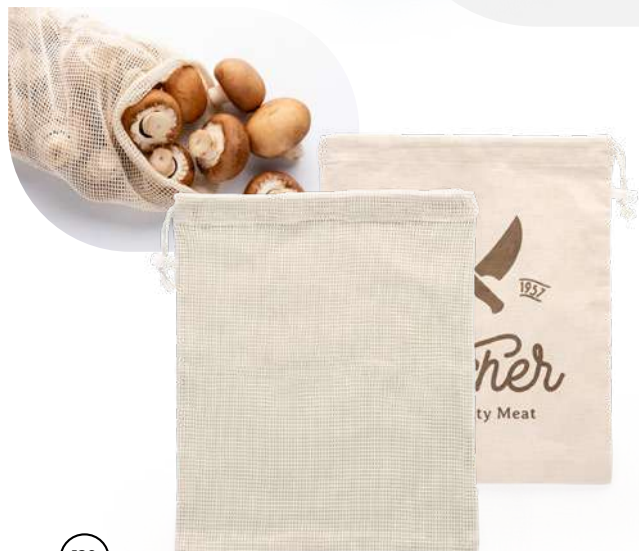

120 gsm

7554 **Soil**

120 gsm cotton bag. One side of the bag in plain fabric and the other in mesh. Adjustable drawstring fastening.

25 x 30 cm

50

250

F(4), N(8)



105 gsm

7552 **Ardea**

Drawstring bag made of 105 gsm cotton.

15 x 21 cm

50

500

F(4), N(8), O, P

NATURELOVERS



120 gsm

7614 **Napa**

Drawstring bag in 120 gsm cotton. Perfect for bottles or thermos.

12 x 33 cm

50

400

F(4), N(8)



NEW.

COTTON & JUTE

NEW RAKU

NEW.

110
g/m²



7185 Raku

Foldable bag in 100% cotton (110 gsm) with bottom in jute. Exterior pocket included. Reinforced 60 cm handles. Easy folding and zip fastening.

35 x 39 x 10 cm 10 100

G(6), H(6), N(8)



JUTE & COTTON



29

60

226

05

7110 Nantes

Bag in laminated jute with long handles and both sides in cotton. Perfect for marking.

40 x 16 x 32 cm 10 50

F(4)

120
g/m²7556 **Wave**

Shopping bag made of 120 gsm cotton and jute, with practical reinforced 70 cm long handles.

37 x 41 cm 10 200

F(6), N(8), O, P

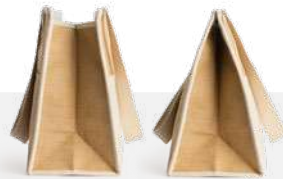

○..... ISOTHERMAL INTERIOR

7161 **Venice**

Cooler bag in laminated jute. Isothermic aluminium lining and velcro fastening. Front pocket and natural cotton handles.

43 x 20 x 34 cm 10 40

F(1), N(8)

7099 **Gavia**

Bag in laminated jute with front pocket and long natural cotton handles.

48 x 15 x 35 cm 10 80

F(1), N(8)





7149 **Nimes**

Natural jute bag with reinforced cotton handles in colour. Sewn edges.

 38 x 41 cm

 10



 80

 F(1), N(8)

29

7148 **Koper**

Natural jute bag with trims and reinforced cotton handles. Sewn edges.

 38 x 42 x 16 cm  10

 50

 F(1), N(8)



7555 **Sterna**

Natural jute bag with 70 cm long cotton handles.

 44,5 x 35 x 14 cm  5  60

 F(1)

100%
JUTE

7164 **Flay**



Sack style bag made of natural jute with cotton drawstring fastening.

 25 x 32 cm  20  200

 F(1),N(8)

7163 **Parma**

Sack style bag made of natural jute with cotton drawstring fastening.

 14 x 22 cm  20  400

 F(1),N(8)



7610 **Grace**

Laminated yute bag with window and double compartment. Perfect for bottles. Reinforced handles.

20 x 34,5 x 10 cm 10 50

G(1), N(8)



7613 **Loire**

Laminated yute and cotton bag. Double compartment and reinforced handles. Perfect for two bottles.

20 x 35 x 35 cm 10 60

F(4), N(8)



7612 **Belona**

Laminated yute and cotton bag. Reinforced handles.
Perfect for bottles.



11 x 35 x 10 cm  20  80
 F(4), N(8)

EVERY DETAIL MATTERS



7611 **Nimba**

Laminated yute bag with window. Reinforced handles.
Perfect for bottles.

10,5 x 35,5 x 10 cm  25  100
 G(1), N(8)

7122 **Olmo**

80 gsm paper bag in natural colour. Reinforced short handles in flat design. Ideal for the hospitality sector (take away).

30 x 29 x 20 cm  200

 F(1)



COTTON HANDLES



7123 **Pinus**

100 gsm paper bag in natural colour. Reinforced short handles in a twisted design. Perfect for bottles.

12 x 36 x 10 cm  100  400

 F(1)

7561 **Milvus**

Tote bag made of resistant 130 gsm laminated paper with cotton handles.

32 x 37,5 cm  1  250

 F(1)



29 01 60 55 02

7541 **Maple**

110 gsm paper bag in natural finish, with reinforced short handles in a twisted design.

41 x 32 x 12 cm 200

F(1)



29 01 60 55 02

7540 **Roble**

110 gsm paper bag in natural finish, with reinforced short handles in a twisted design.

32 x 40 x 12 cm 250

F(1)



29 01 60 55 56 02

7539 **Haya**

110 gsm paper bag in natural finish, with reinforced short handles in a twisted design.

22 x 23 x 9 cm 250

F(1)



29 01 60 55 56 02

7538 **Arce**

110 gsm paper bag in natural finish, with reinforced short handles in a twisted design.

25 x 31 x 11 cm 250

F(1)



RECYCLING SET

7147 Volga

Set of 3 recycling bags made of resistant laminated pp-woven fabric in matt finish with side velcro strips and reinforced handles. 40 litres capacity on each bag.

99 x 44 x 28 cm 1 40
F(1)



01 31 60 05 226 02

7543 Coast

Reusable bag in gloss laminated finish, made of resistant 120 gsm woven PP with reinforced nylon handles and matching black piping.

39 x 39 x 15 cm 20 100
F(1)





01 03 31 60



40 05 226 02



RECYCLED PET

7534 Phoca

Reusable sewn bag in matt laminated finish. Made from resistant 100 gsm non-woven RPET with reinforced handles.

41 x 37 cm 10 250 F(1)



01 60 05 226



RECYCLED PET

7535 Orca

Reusable shopping bag in matt laminated finish. Made from resistant 100 gsm non-woven RPET with reinforced handles and matching piping.

42 x 35 x 15 cm 10 200 F(1)



01 60 05 226 02



RECYCLED PET

7549 Pantala

Foldable shopping bag made from soft 210T recycled polyester. Practical pocket for folding included.

33 x 46 x 8 cm 20 400 F(1), G(1), R



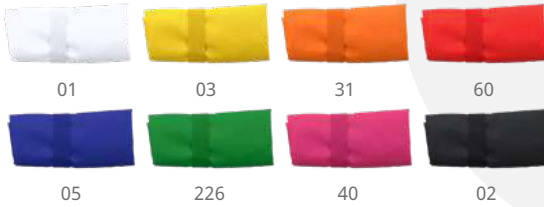

7522 Toco

Foldable shopping bag in soft 190T polyester in stitched finish. Includes practical elastic band for folding.

42,5 x 38 x 7 cm 1/20 400

F(1), G(1), H(1), R



7523 Focha

Foldable shopping bag in soft 190T polyester. Assorted fruit designs with drawstring fastening.

40 x 38 cm 10 400

F(1), G(1)



SHOPPING BAGS



7128 Trevel

Ham pouch made of resistant non-woven fabric with reinforced handles and zip fastening. Sewn edges.

68 x 41 cm 1/50 100

F(1)

NON WOVEN PRODUCTS



01 31 60 05 226 02

7166 Barnett

Large bag in 80 gsm non-woven with reinforced 58 cm long handles and sewn finish.

33 x 38 x 25 cm 10 200

F(1)



7125 **Boden**

80 gsm non-woven bag with reinforced 35 cm short handles and heat-sealed edges.

 38 x 35 cm
  50
  250
 F(1)

COLORFULL BAGS



7503 **Lake**

Heat-sealed bag with short handles, in 100 gsm non-woven.

 35 x 40 x 12 cm
  50
  250
 F(1)



7502 **River**

Heat-sealed bag for bottles with die-cut handle, made of 80 gsm non-woven.

17 x 40 x 10 cm 50 1000
 F(1)



7501 **Ocean**

Heat-sealed bag in 80 gsm non-woven with die-cut handle.

40 x 30 x 10 cm 50 400
 F(1)



7504 **Sea**

Heat-sealed bag in 80 gsm non-woven with hexagonal gusset and long handles.

54 x 40 x 10 cm 50 250
 F(1)

NON WOVEN SUBLIMATION BAGS



7527 **Mito**
SUBLIMATION



7127 **Trento**
SUBLIMATION



7506 **Crest**

Heat-sealed 80 gsm non-woven bag with 70 cm long handles. Heat-sealed finish.



7126 **Donet**

80 gsm non-woven bag with resistant die-cut handles and heat-sealed edges.



7527 **Mito**

Sewn non-woven shopping bag with reinforced handles. Perfect for sublimation. 70 cm long handles.



7127 **Trento**

80 gsm non-woven bag with resistant die-cut handles and heat-sealed edges. Perfect for sublimation.





COTTON TOUCH

7618 Miso

Tote bag, ideal for sublimation in soft resistant polyester.
70 cm long handles.

 42 x 38 cm

 10

 100

 F(6), N(8), R

SPECIAL FOR

SUBLIMATION



COTTON TOUCH

7569 Osak

Toilet bag, ideal for sublimation in soft polyester with inner lining. Zip with matching puller.

 22 x 14 x 6,5 cm

 1/25

 500

 F(1), N(8), R



COTTON TOUCH

7180 Kanda

Drawstring backpack, ideal for sublimation in soft resistant polyester.

 42 x 34 cm

 10

 100

 F(1), N(8), R

EATING & DRINKWARE

BOROSILICATE
GLASS3986 **Adaya**

Frosted borosilicate glass mug, special for sublimation.
500 ml capacity. Presentation in white box.

15,1 x Ø8,10 cm 1

20

Q

BOROSILICATE
GLASS4148 **Puket**

Frosted borosilicate glass cup, special for sublimation. 330 ml capacity. Presentation in white box.

9,3 x Ø7,80 cm 1

30

Q

DISCOVER OUR NEW SUBLIMATION MUGS

3987 **Samui**

Ceramic mug in a glossy finish, special for sublimation.
700 ml capacity. Presentation in white box.

13,8 x Ø10,40 cm 1

20

Q



PREMIUM QUALITY

3999 **Lemon**



350 ml

3999 **Lemon**

High quality ceramic mug, special for sublimation. 350 ml capacity. Individual box not included. Presentation in a 36-unit box.

9,6 x Ø8,20 cm 1

36



4003 **Rambu**



MATT FINISH

4000 **Lima**



4084 **Marang**



SUBLIMATION MUGS

350 ml

4003 **Rambu**

350 ml ceramic mug in a matt finish design. Special for sublimation. Presentation in white box.

9,6 x Ø8,20 cm 1

36



350 ml

4000 **Lima**

350 ml ceramic mug, special for sublimation. Presentation in white box.

9,6 x Ø8,20 cm 1

36



250 ml

4084 **Marang**

250 ml ceramic mug, special for sublimation. Presentation in white box.

8,4 x Ø7,40 cm 1

48



MAGIC
MUGS

350ml

4085 **Okra**

Ceramic magic mug in matt finish. 350 ml capacity. Pour hot liquids in it and discover the hidden design. Presentation in white box.

9,6 x Ø8,20 cm 1

36

F(1), Q



340ml

4060 **Kaffir**

340 ml glass mug. Special for sublimation. Presentation in eco box.

9,5 x Ø8 cm 1 36

F(1), Q



350ml

4001 **Mango**

350 ml ceramic mug, special for sublimation. Inside and handle in colour. Presentation in white box.

9,6 x Ø8,20 cm 1

36

Q



300ml

4002 **Kumbo**

Retro style ceramic mug, special for sublimation. 300 ml capacity. Presentation in white box.

8,5 x Ø8,70 cm 1

36

Q



0103

0131

0160

0105

01226

0102



0160

0105

0102



3996 **Walax**

Ceramic mug with white interior, ideal for laser printing. 350 ml capacity. Presentation in white box.

9,6 x Ø8,20 cm 1



F(1), L2



SPECIAL FOR LASER ENGRAVING

WALAX & MACHA



3997 **Macha**

Ceramic mug with colour interior, ideal for laser printing. 350 ml capacity. Presentation in white box.

9,6 x Ø8,20 cm 1



F(1), L2



SPECIAL FOR LASER ENGRAVING
NEWROIBO

NEW.

350 ml



226

03



60

05

02

3992 Roibo

Ceramic mug, ideal for laser printing. Colour inside and white exterior. 350 ml capacity. Presentation in white box.

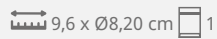
 9,6 x Ø8,20 cm 1

 36

 F(1), L2

350 ml



251

260

4024 Zala

350 ml ceramic mug in a gloss finish design. Special for laser engraving. Presentation in white box.

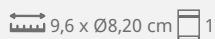
 9,6 x Ø8,20 cm 1

 36

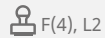
 F(4), L2

DO NOT MICROWAVE





300 ml

4010 **Jack**

Ceramic mug with a round handle, in a vintage style design. 300 ml capacity. Presentation in white box.

8,6 x Ø8,50 cm 1 36
F(4)



0101 0301 3101 6001 24201 11401



03 31 60
242 114 02

300 ml

4009 **Nolo**

Ceramic mug in colour glaze. 300 ml capacity. Presentation in white box.

10,4 x Ø8,50 cm 1 36
F(4)



350 ml

4008 **Akebia**

350 ml ceramic mug. Inside and spoon in matching colour. Presentation in white box.

10,5 x Ø8,30 cm 1 36
F(4)



0103 0131 0160 0105 01226



370 ml

4005 **Yuca**

370 ml ceramic mug. Presentation in white box.

9,8 x Ø8,20 cm 1

36

F(4)



370 ml

4006 **Papaya**

370 ml colour ceramic mug. Presentation in white box.

9,8 x Ø8,20 cm 1

36

F(4)

350 ml

4007 **Palta**

350 ml slate cup. Chalk included. Presentation in white box.

9,6 x Ø8,20 cm 1

36

F(1)



01

03

60

05





4057 **Sacha**

380 ml reusable cup. Body in PP and a covering layer of natural cork. Presentation in an eco design box.

8,5 x Ø11 cm 1 40

F(1), L1



MATT FINISH



4013 **Rosella**

Ceramic mug in a matt finish design with a natural cork bottom. 420 ml capacity. Presentation in kraft cardboard box.

11 x Ø9 cm 1 36

F(1)



4012 **Berry**

Ceramic mug in matt finish with a natural bamboo lid. 370 ml capacity. Presentation in a kraft cardboard box.

10,5 x Ø8,20 cm 1 36

F(1), L2



MATT FINISH

+ antibacterial

ISO 22196



4064 Gosto

Antibacterial foldable cup with lid and silver carabiner. 220 ml capacity.

9 x Ø3,70 cm 1/50



D(4), W



4062 Bustan

Reusable PLA cup with screw lid and 450 ml capacity.

13,5 x Ø9,40 cm 1



F(1)



4063 Parcha

Reusable PLA mug with 350 ml capacity.

8,8 x Ø7,90 cm 1/50 100

F(4)



4065 Yobo

PLA lunch box with tightening polyester strap. Fork, spoon and knife included. 1 litre capacity.

19,1 x 7,4 x 11,8 cm 1



E(1), W

METAL MUGS

SUBLIMATION



380 ml

4014 Damasco

380 ml metal mug, special for sublimation. Vintage style. Presentation in white box

7,9 x Ø8,80 cm 1

48

L2, Q



0101

0301

6001

0501

5601

0201

380 ml

4015 Anon

380 ml metallic mug in a vintage style. Presentation in white box.

7,9 x Ø8,90 cm 1

48

F(4), L1



05

02

60

251

226

290 ml

4083 Kiwan

Metal mug with double wall and colour exterior. 290 ml capacity. Presentation in white box.

9 x Ø7,70 cm 1 50

F(1), L1

1,2 L

4069 **Brena**

Lunch box made of 304 stainless steel with side-buckles fastening. 1,2 litres capacity. Presentation in eco design box.

19,6 x 7 x 13,6 cm 1

20

F(1), L2

**NEW.**

450 ml

3985 **Teide**

304 stainless steel mug with foldable handles. 450 ml capacity. Presentation in white box.

8,2 x Ø9,20 cm 1

50

F(1), L2



NEW
TEIDE



03

60

05

226

02

230 ml

4082 **Guaya**

Metal mug with double wall and carabiner handle. 230 ml capacity. Presentation in white box.

8 x Ø7 cm 1

50

F(1), L2





4066 **Korlan**

Lunch box made of 304 stainless steel with bamboo lid and tightening strap in polyester. 800 ml capacity. Presentation in eco design box.

15,8 x 6,1 x 11,9 cm 1 30

F(1), L2



4103 **Daikon**

304 stainless steel lunch box with bamboo lid. Side-buckles fastening. 1 litre capacity. Presentation in eco design box.

19,4 x 6,8 x 13,1 cm 1 20

E(1), L2



4117 **Colmer**

Natural bamboo cutlery set in a natural cotton drawstring pouch. Fork, knife and spoon included.

6,5 x 1 x 22 cm 1/100 300

F(1), B(4), L1, N(8)





4077 Malow

Set of 2 straws in 304 stainless steel, in a cotton pouch. Cleaning brush included.

25,5 x 6 cm 1/100

400

E(1), L1, N(8)



01

02

4068 Ladas

Reusable and extendable straw in 304 stainless steel with silicone nozzle. Cleaning brush and case with carabiner included.

10,5 x Ø1,60 cm 1/100 500

E(1), L1



CUTLERY SET



4030 Belver

Cutlery set made of stainless steel in a practical neoprene pouch. Fork, spoon and knife included.

21 x 6 cm 1 100

F(1), L2

1L



4107 **Dalia**

Lunch box in borosilicate glass with air-tight lid. 1 litre capacity. Presentation in design box.

20,6 x 7 x 15,6 cm 1

20

F(1)



GLASS LUNCH BOX



BAMBOO

900 ml

4061 **Sambal**

Lunch box in borosilicate glass with bamboo lid and silicone strap. 900 ml capacity. Presentation in eco design box.

20 x 6 x 15 cm 1

20

E(1), L2

RPET COOLER BAGS



BISMAR

MARLOX



243

255

RECYCLED
PET

7609 Marlox

XL cooler bag made of RPET polyester in a heather design. Double compartment and front pocket. Isothermic lining. Adjustable carry strap included.

30 x 25 x 20 cm 1

25

F(1), N(8)



243

255

RECYCLED
PET

7608 Bismar

Cooler bag made of RPET polyester in a heather design. Isothermic lining and front pocket. Adjustable carry strap included.

25 x 15,5 x 15,5 cm 1

60

F(1), N(8)



4133 **Vertus**

Double wall glass in borosilicate glass with bamboo lid. 350 ml capacity. Presentation in eco design box.

13,6 x Ø8,90 cm 1

40

F(1), L2

GLASS & BAMBOO



3998 **Indal**

Double wall mug in borosilicate glass with bamboo lid. 280 ml capacity. Presentation in eco design box.

9,6 x Ø8,80 cm 1

40

F(1), L2



4081 **Coco**

Mug in borosilicate glass with bamboo lid and spoon. 420 ml capacity. Presentation in eco design box.

9,5 x Ø8 cm 1

36

F(1), C(4), L2

FOR COFFEE LOVERS

BOROSILICATE
GLASSDOUBLE
WALL

90ml

4132 Capsul

Set of 2 double wall glasses in borosilicate glass. 90 ml capacity. Presentation in eco design box.

6,6 x Ø6,70 cm 1/12  24

 F(1)



NEW.

GLASS | BAMBOO

NEW BOTTLES



BO **350ml**
BOROSILICATE GLASS

4202 **Dalby**

Borosilicate glass tumbler in a colour gradient frosted effect. Bamboo lid and straw. 350 ml capacity. Presentation in eco design box.

14 x Ø7,50 cm 1 30
F(1), L2



BO **BAMBOO** **NATURAL CORK** **450ml**
BOROSILICATE GLASS

4138 **Iroko**

Tall glass in borosilicate glass with natural cork pouch. Bamboo lid and straw. 450 ml capacity. Presentation in eco design box.

18 x Ø6,80 cm 1 30
F(1), G(1), N(8)



GLASS CORK

VACUUM FLASK



NEW.



4211 Coiba

304 stainless steel thermal bottle with double wall and bamboo details. Lid with double function handle, as mobile stand. 450 ml capacity. Presentation in eco design box.

22 x Ø7 cm 1 50

F(1), L2, W

NEW.



4206 **Cedro**

Double wall thermos in 304 stainless steel and natural bamboo with tea filter. Touch digital thermometer on the lid. 480 ml capacity. Button battery included. Presentation in eco design box.

23,5 x Ø6,50 cm 1

30

F(1), L2, W



BAMBOO THERMOS



4032 **Kinata**

Double wall 304 stainless steel thermos. Exterior wall in natural bamboo. 500 ml capacity. Presentation in eco design box.

24,5 x Ø6,90 cm 1

30

F(1), L2, W



BAMBOO & STAINLESS STEEL

4097 **Pana**4100 **Sotos**4035 **Fengi**4033 **Yaba**

4097 **Pana**

Double wall mug made of stainless steel with outer layer in natural bamboo. Dispensing lid. 340 ml capacity. Presentation in eco design box.

10,8 x Ø8,20 cm 1

50

F(1), L2



4100 **Sotos**

304 stainless steel bottle with bamboo cap. Carry strap included. 600 ml capacity. Presentation in design box.

22 x Ø6,30 cm 1

50

F(1), L2, L3, W



4035 **Fengi**

304 stainless steel vacuum flask with double wall and bamboo body. 420 ml capacity. Carry strap included. Presentation in eco design box.

25,5 x Ø6 cm 1 25

F(1), L2



4033 **Yaba**

304 stainless steel tumbler with exterior wall in natural bamboo. 500 ml capacity. Presentation in eco design box.

17,5 x Ø8,20 cm 1

50

F(1), L2, W

NEW.



4203 **Saoko**

Borosilicate glass bottle with double wall and bamboo cap. Tea filter included. 420 ml capacity. Presentation in eco design box.

23,9 x Ø7 cm 1 20

F(1), L2, W



FOR **TEA**
LOVERS

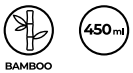

4020 **Trilby**

450 ml glass bottle with bamboo cap and carry strap in natural finish. Presentation in eco design box.

19,7 x Ø6,40 cm 1

50

F(1), L2, W



4136 **Lawas**

Glass bottle with natural cork pouch. Bamboo cap with practical carry strap. 500 ml capacity. Presentation in eco design box.

22,5 x Ø6,40 cm 1

30

F(1), G(1), N(8)



GLASS BOTTLES

4137 **Sibu**

Glass bottle with faux jute pouch and bamboo cap with practical carry strap. 500 ml capacity. Presentation in eco design box.

22,5 x Ø6,40 cm 1

30

F(1), G(1), N(8)



01

60

05

226

02

4055 **Nagami**

Glass bottle with bamboo cap and colour silicone pouch. 540 ml capacity. Presentation in design box.

23,1 x Ø6,70 cm 1

30

G(1), L2





500-ml

4040 **Camu**

500 ml glass bottle. Pouch and carry strap in matching colour. Presentation in design box.

22 x Ø6,70 cm 1

40

F(1), G(1), N(8), L2, Q

SUBLIMATION



600-ml

4098 **Kaster**

600 ml glass bottle with colour pouch and carry strap. Presentation in design box.

16,2 x Ø8,80 cm 1

40

F(1), N(8), L2, R



CHOOSE YOUR FAVOURITE COLOUR



00

31

60



05

226

02

650ml

4099 **Sandi**

Glass bottle with translucent colour body. Stainless steel cap. 650 ml capacity. Presentation in design box.

26 x Ø7,10 cm 1

30

F(1), L2, W



GLASS BOTTLES



00

03

31

60

500ml

4037 **Alfe**

Glass bottle with colour body. 500 ml capacity. Carry strap included. Presentation in design box.

22 x Ø6,30 cm 1

50

F(1), L2, W



40

05

226

02

CHOOSE YOUR SIZE, CHOOSE YOUR FINISH.

MATT & SHINY

4093 Yisel

4149 Kemy



SAME DESIGN



500ml



4149 Kemy

Double wall thermal bottle in 304 stainless steel. 500 ml capacity. Presentation in design box.

23,5 x Ø6,80 cm 1

30

F(1), L2, L3, W



01 165 60 43 271 02



750ml



4093 Yisel

Thermos bottle in 304 steel with double wall and copper vacuum. 750 ml capacity. Presentation in design box.

28,5 x Ø7,30 cm 1

20

F(1), L2

DIFFERENT SIZE



4122 **Balax**

Thermos bottle in 304 stainless steel. Double wall with copper vacuum insulation. 550 ml capacity. Presentation in design box.

22,5 x Ø7,40 cm 1



F(1), L2, L3, Q



NEW.
COLOR

SUBLIMATION



01



60



05



02



251



281



260

BALAX



SUBLIMATION



01

03

60



05

226

02

800ml

4144 **Magun**

304 stainless steel bottle in solid finish. 800 ml capacity.
Presentation in design box.

22,5 x Ø7,40 cm  1

 40

 F(1), L2, L3, Q

W
O
O
A
M
L
B
U



DOUBLE WALL



500ml



4126 **Fancy**

304 stainless steel thermos bottle. Double wall with copper vacuum. 500 ml capacity. Presentation in design box.

26,3 x Ø7 cm 1 30

F(1), L2, L3, W

SUBLIMATION



01



60



05



260



251



02





SUBLIMATION

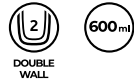

4139 **Torke**

Double wall thermos bottle in 304 stainless steel. 600 ml capacity. Presentation in design box.

26 x Ø6,90 cm 1 30
 F(1), L2, L3

NEW.

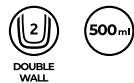

4059 **Copo**

Thermos bottle in 304 stainless steel with double wall, special for sublimation. 500 ml capacity. Presentation in design box.

25,5 x Ø7,30 cm 1 24
 L2, L3, Q

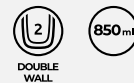

4145 **Beluga**

304 stainless steel bottle with double wall. 850 ml capacity. Presentation in design box.

30,5 x Ø8 cm 1 30
 F(1), L2, L3, W



01

251

02



DOUBLE WALL



NATURAL CORK



460ml



4056 **Tayox**

Double wall thermos bottle made of 304 steel with tea filter and cork base. 460 ml capacity. Presentation in design box.

24,5 x Ø6,40 cm 1

30

F(1), L2



TAYOX

DOUBLE WALL | 460ML.

CORK & STAINLESS STEEL



01

251

02



DOUBLE WALL



NATURAL CORK



520ml



4105 **Kale**

Thermos bottle in 304 stainless steel with double wall and cork base. 520 ml capacity. Presentation in design box.

27 x Ø7,10 cm 1

30

F(1), L2

SUBLIMATION

DOUBLE WALL | 500ML.

NEW TISSET



01

60

05

242

226

251

02



DOUBLE WALL



500ml

NEW.



4201 **Tiset**

Double wall bottle in 304 stainless steel with bamboo cap. 500 ml capacity. Presentation in design box.

21 x Ø7,30 cm 1

30

F(1), L2, L3, W, Q



SUBLIMATION



01

60

05

251



BAMBOO



620ml

4039 **Boina**

304 stainless steel and bamboo bottle. 620 ml capacity. Presentation in design box.

21 x Ø7,30 cm 1

50

F(1), L2, Q



SUBLIMATION



500ml



4123 **Salvia**

304 stainless steel thermos bottle with double wall. Glossy finish. 500 ml capacity. Presentation in design box.

24,5 x Ø6,90 cm 1

30

F(1), L2, L3

01

60

05

251

02



SUBLIMATION



01

251

02



450ml

4106 **Palmer**

Thermos bottle in 304 stainless steel with double wall. Opening button with security fastening. 450 ml capacity. Presentation in design box.

22 x Ø6,50 cm 1

30

F(1), L2



450ml



60

05

251

4135 **Dango**

Double wall thermos container in 304 stainless steel, perfect for your food. Double lid with foldable stainless steel spoon included. 450 ml capacity. Presentation in design box.

15,7 x Ø9,50 cm 1

20

F(1), L2, L3



06 55 56 02



DOUBLE WALL

450ml



STAINLESS STEEL | DOUBLE WALL

THERMO CUP



4134 Okele

Double wall insulated tumbler in 304 stainless steel. Practical spill-proof drinking screw lid. 450 ml capacity. Presentation in design box.

14,6 x Ø8,90 cm 1



F(1), L2, L3

NON-SLIP BASE



01 31 60 05 226 251 02

290ml

4029 Milu

290 ml stainless steel tumbler with PP lid. Presentation in design box.

14,4 x Ø7,30 cm 1



F(1), L2, L3, W



01 60 05 251 02

310ml

4028 Salak

310 ml stainless steel tumbler with PP lid. Presentation in design box.

16,7 x Ø7,20 cm 1



F(1), L2, W

BOTTLES

STAINLESS STEEL



4125 **Tarek**



4042 **Alpinia**



4200 **Selby**



01 03 31 60



40 05 226 02



01 60 05 251 02

790ml

4125 **Tarek**

304 stainless steel bottle in matt finish. 790 ml capacity. Presentation in design box.

25,7 x Ø7,40 cm 1 50
F(1), L2, L3, W

700ml

4042 **Alpinia**

304 stainless steel bottle. 700 ml capacity. Presentation in design box.

25,5 x Ø7,10 cm 1 50
F(1), L2, L3, W

700ml

4200 **Selby**

304 stainless steel bottle, special for sublimation. 700 ml capacity. Presentation in design box.

25,7 x Ø7,10 cm 1 40
L2, L3, Q



01

60

05

226

02



4011 Pita

304 stainless steel bottle. 630 ml capacity. Solid colour design in matt finish. Presentation in design box.

25,5 x Ø7,10 cm 1

30

F(1), L2, L3, W



01

60

05

02



4034 Alke

304 steel bottle with two-colour body in matt finish. Screw cap with flexible rubber strap. 850 ml capacity. Presentation in design box.

24,7 x Ø7,50 cm 1

30

F(1), L2, L3



60

05

226

251

02



NEW.

4212 **Lewik**

Bottle in recycled aluminium with matching cap and carry handle. 600 ml capacity. Presentation in eco design box.

22,5 x Ø6,60 cm 1 50

F(1), L2, L3, W

RECYCLED ALUMINIUM

RECYCLED ALUMINIUM



01

60

05

226

251

02

**NEW.**

4214 Renko

Bottle in recycled aluminium with matching carabiner. 400 ml capacity. Presentation in eco design box.

17,5 x Ø6,60 cm  1

 50

 F(1), L2, L3, W

**NEW.**

4213 Kisko

Bottle in recycled aluminium. 550 ml capacity. Presentation in eco design box.

23,5 x Ø6,60 cm  1

 50

 F(1), L2, L3, W



01

60

05

226

251

02

ALUMINIUM & BAMBOO
NEWBOTTLES

NEW.



4205 Broly

NEW.



4204 Gelda



4205 **Broly**

Aluminium bottle with carabiner and bamboo cap. 800 ml capacity. Presentation in eco design box.

24,3 x Ø7,30 cm 1 40

F(1), L2, L3, W



4204 **Gelda**

Aluminium bottle with carabiner and bamboo cap. 400 ml capacity. Presentation in eco design box.

17,1 x Ø6,60 cm 1 50

F(1), L2, L3, W

SUBLIMATION



01 60 05 226 02

4049 **Baobab** (800ml)

Aluminium bottle with carabiner. 800 ml capacity. Presentation in design box.

24,6 x Ø7,30 cm 1 50

F(1), L2, L3, W, Q



4045 **Athletic**



4049 **Baobab**



4004 **Yaca**

SUBLIMATION



01 60 05 226 251 02

4045 **Athletic** (400ml)

Aluminium bottle with carabiner. 400 ml capacity. Presentation in design box.

17,5 x Ø6,60 cm 1 50

F(1), L2, Q



01 03 60 05 226 02

4004 **Yaca** (330ml)

Aluminium bottle with carabiner in matching colour. 330 ml capacity. Presentation in design box.

15 x Ø6,60 cm 1/50 100

F(1), L2, L3



01 03 60 05



226 251 02

680 ml

4058 **Chito**

Aluminium bottle with body in solid finish. 680 ml capacity. Cap with retractile nozzle and carry strap. Presentation in design box.

22,1 x Ø7,30 cm 1

50

F(1), L2



00 31 60 05 226 02



4067 **Valsan**

RPET bottle with translucent coloured body. 600 ml capacity. Carry strap included. Presentation in eco design box.

21,5 x Ø6,50 cm 1

50

F(1), L2

100%
RPET



4041 **Eddo**

700 ml bottle in transparent AS finishing. Cap and base in stainless steel. Presentation in design box.

26,5 x Ø7,10 cm 1 30

F(1), L2, W



4038 **Kinkan**

Tritan bottle with colour semitransparent body. Matching cap with in-built carry handle. 650 ml capacity. Presentation in design box.

25,7 x Ø6,70 cm 1 50

F(1), W

CHOOSE YOUR BOTTLE



4044 **Aloe**

600 ml bottle made of tritan. Cap and carry strap in colour. Presentation in design box.

22,5 x Ø6,60 cm 1 50

F(1), W



SOFT FLASK



01 05

4104 Trail

Soft flask in malleable TPU with carry handle included. Ideal for sports events. 500 ml capacity.

25 x 9 cm 1/50 400

F(1)



01 05

4119 Track

Ideal soft cup in malleable TPU for sports events. 230 ml capacity.

10,7 x Ø6,80 cm 1/50 600

F(1)



01 03 60 05 226



4086 Mandy

Malleable PET bottle in the shape of a t-shirt. Security cap and carabiner. 470 ml capacity.

17 x 25,5 x 3,3 cm 1/50 400

E(1)



01 03 31 60 05 226 02



520ml

4046 Running

PE bottle for sports. 520 ml capacity.

19,5 x Ø6,50 cm 1/10 100

F(1)



SPORT BOTTLES



01 03 31 60 05 226 02



840ml

4036 Kumat

Sports PE bottle with 840 ml capacity.

23,5 x Ø7,50 cm 1/10 50

F(1)



01 03 31 60 05 226 02



620ml

4047 Biking

PE bottle for sports with wide printing surface. 620 ml capacity.

20,5 x Ø7,50 cm 1/10 100

F(1)



HOME, GIFTS & PREMIUM



NEW.



NEW.



HEMP FABRIC



200 g/m²



9139 **Bost**

Long twill apron in recycled polyester and cotton. Neck strap with adjustable fastening. Side tie-straps. Two front pockets.

70 x 90 cm



E(4), N(8)



200 g/m²



9140 **Maule**

Apron in hemp fabric (200 gsm), with front pocket. One size adjustable.

65 x 90 cm



E(4), N(8)

NEW.



9142 **Nopal**

Kitchen towel in 100% cotton (180 gsm).

40 x 65 cm 10 200
 F(1), N(8), O, P



FAIRTRADE COTTON

NEW.



9143 **Peyot**

Table mat in 100% Fairtrade cotton (140 gsm).

45 x 30 cm 10 300
 F(1), N(8), O, P



9141 **Taber**

Apron in 100% Fairtrade cotton with front pocket. One size adjustable.

65 x 90 cm 10 100
 E(4), N(8), P



RECYCLED COTTON



226



29



60



02



05



RECYCLED COTTON

9136 Arola

Apron made of recycled cotton in heather finish. Front pocket. One size adjustable.

93 x 65 cm

10

100

F(4), N(8), P



ORGANIC COTTON

9135 Oliver

Apron in 100% organic cotton with front pocket. One size adjustable.

93 x 65 cm

10

100

F(4), N(8), P

SMOOTH SIDE FOR MARKING

**NEW.**

RECYCLED COTTON

9144 Forset

Kitchen mitt in 100% recycled cotton, with a flat side ideal for marking and a hanging strap.

18,5 x 26 cm

1/50

200

E(1), N(8)

SMOOTH SIDE FOR MARKING



ORGANIC COTTON

9138 Mauro

100% organic cotton kitchen mitt with hanging strap and one flat side ideal for marking.

30,5 x 19 cm

1/25

200

E(1), N(8)



9128 Ramsay



9129 Ducasse



9128 Ramsay

Long apron in twill.
· Matching neck strap.
· Side tie-straps.

65 x 90 cm 50 100
Consult



9129 Ducasse

Long apron with double front pocket and matching tie-straps. 90% polyester and 10% cotton (150 gsm). Removable label. One size. Pocket measures: 25 x 16 cm.

65 x 90 cm 10 100
Consult



9133 Jamie

Children's apron and hat set, made of 80 gsm non-woven. Adjustable one size. Apron pocket measures: 17 x 17 cm.

APRON: 59,5 x 49 cm HAT: 30 x 20 cm
10 300 F(1)



9130 Keller

Colour non-woven apron with front pocket. Adjustable one size. Pocket measures: 22 x 17 cm.

50 x 73 cm 10 200
F(1)



9134 Roger

White polyester kitchen mitt with colour edging and hanging strap. Flat side ideal for sublimation.

19 x 30,5 cm

1/50

200

E(1), N(8), R



SPECIAL FOR SUBLIMATION



SMOOTH SIDE
FOR MARKING



9137 Eneko

Kitchen set with pot holder and mitt in soft cotton/polyester. One flat side ideal for marking and hanging strap.

30,5 x 19 cm

1/10

100

E(1), N(8)

KITCHEN GLOVES



SMOOTH SIDE
FOR MARKING

9132 Roca

Soft cotton/polyester kitchen mitt with a smooth face for marking.

19 x 30,5 cm

25

200

E(1), N(8)



NEW.



BAMBOO



4 147 **Baru**

Kitchen spatula in natural bamboo.

6 x 30 cm

1/50

200

C(4), L1



NEW.

NEW KITCHEN ACCESSORIES



BAMBOO



4 146 **Nori**

Kitchen spoon in natural bamboo.

6 x 30 cm

1/50

200

C(4), L1



BAMBOO



5 KG



3028 **Rabil**

Digital kitchen scales with natural bamboo surface. 5 kg maximum weighing capacity. Button battery included. Presentation in eco design box.

15 x 1,6 x 21,5 cm

1/10

20

E(1), L2, W



4116 **Angus**4114 **Devon**4115 **Boran**

BAMBOO

4114 **Devon**

Natural bamboo chopping board. Die-cut for hanging and easy handling. Presentation in eco box.

15,3 x 1 x 20 cm  1  50
 E(1), L2



BAMBOO

4115 **Boran**

Wooden chopping board with grip for easy handling and a piece of cord for hanging. Presentation in eco box.

40 x 1 x 13,5 cm  1  30
 E(1), L2



BAMBOO

4116 **Angus**

Natural bamboo chopping board with juice rim. Presentation in eco box.

30 x 1,2 x 20 cm  1  20
 E(1), L2

CUTTING BOARDS



4102 **Comte**

Cheese set with 4 utensils in stainless steel and wooden handle. Presentation in a practical wooden case with chopping board on the top surface and white box.

3,6 x Ø20 cm



1



10

E(1), L2

WOOD & STAINLESS STEEL

FOR CHEESE LOVERS



4101 **Edam**

Cheese set with 4 utensils in stainless steel and wooden handle. Presentation in an elegant case with inner padding.

21,5 x 3,4 x 17,4 cm



1/10



40

F(1), L1



4140 **Pinea**

4-coaster set in natural pine wood. Presentation tied with a natural jute cord inside an eco design box.

10 x 4,5 cm

1/25

50

E(1), L2

WOOD & CORK



4113 **Algor**

4-coaster set in natural bamboo. Presentation in eco design box.

11,6 x 3,6 x 11,6 cm

1

20

E(1), L2



4087 **Chala**

Natural cork coaster.

Ø10 cm

10/500 1000

D(1), L1, W

NEW WINE COOLERS



NEW.



NEW.

VELCRO FASTENER



57

55

02

7082 Frost

Bottle cooler sleeve in polyester, with elastic straps for a perfect adjustment.

15,5 x 22,5 cm

1/25

50

F(1)



7081 Moke

Bottle cooler sleeve in RPET, with adjustable velcro fastening.

40 x 18 cm

1/25

50

F(1)



4112 Malbec

Wine set with stainless steel accessories: pulltap corkscrew with folding blade, drip ring, stopper and pouring spout. Presentation in metal box with inner padding.

18 x 4 x 11 cm 1 20

G(1), L2



WINE LOVERS



01 116 02

4075 Merlot

Classic stainless steel corkscrew with double lever. Presentation in white box.

12 x 2,1 x 1,3 cm 1/10 200

D(1), L1



01 60 05 02



4118 Garnac

Classic stainless steel corkscrew with folding blade and bottle opener. Presentation in white box.

11 x 1,2 x 2,2 cm 1/10 200

D(1)



4076 Syrah

Metal corkscrew in the shape of a bottle. Presentation in white box.

12 x Ø2,50 cm 1/50 200

D(1)





NATURAL
CORK



4091 **Venet**

Wine set with stainless steel accessories: pulltap corkscrew with double lever and folding blade, drip ring, pouring spout and stopper. Presentation in a natural cork case with inner padding.

4,2 x Ø14,90 cm 1 20

F(1), L2



4 ACCESSORIES



WINESET

CORK | WOOD



BAMBOO



4129 **Tintos**

Wine set with stainless steel and bamboo accessories. Pulltap corkscrew with folding blade, stopper and drip ring. Presentation in a bamboo case with inner padded lining and eco design box.

16 x 4,8 x 10 cm 1 20

E(1), L2





4078 Shake

Opener in natural wood with stainless steel interior and die-cut on the opposite end for hanging.

17,9 x 4,1 cm 1/50 100

D(4), L1, W



4111 Colins

Natural bamboo bottle opener in a compact design with stainless steel interior and upper die-cut for hanging.

10,5 x 1 x 4 cm 1/50 200

D(4), L1



4090 Roden

Stainless steel opener with natural wood handgrip.

4 x 14,3 x 2,1 cm 1/50 200

D(4), L1, W



4088 Sherry

Bamboo opener with magnet. Alternative use as a coaster.

1,1 x Ø6 cm 1/50 500



D(4), L1, W



580ml

3993 **Larius**

304 stainless steel cocktail set. Accessories included: measuring jigger, 580 ml shaker, strainer and stirrer. Carry pouch included. Presentation in design box.

 29,5 x Ø8,70 cm  1  20

 F(1), L2



COCKTAIL SET | STAINLESS STEEL

LARIUS

MAKE YOUR BEST COCKTAIL

MADE IN STAINLESS STEEL



700ml

3994 **Daniel**

Stainless steel cocktail shaker with spill-proof lid and pouring cup. 700 ml capacity. Presentation in design box.

16,1 x Ø8,80 cm

1

40

F(1), L2

3995 **Cardu**

Dual stainless steel measuring jigger. 15 and 30 ml capacity. Presentation in white box.

6,9 x Ø3,90 cm

1/50

200

F(1), L1



175ml

4141 **Walker**

Stainless steel hip flask with spill-proof screw cap. 175 ml capacity. Presentation in design box.

9,3 x 11,2 x 2,1 cm

1/50

100

F(1), L2



NEW.

1040 **Viza**

Wooden skittles set with 10 pins and 2 balls. Easy to carry cotton pouch included. Presentation in eco design box.

32 x 34 cm



1



8

G(1)

WOODEN GAMES

1014 **Galvy**

Set of 4 games of skill: mikado, chess, draughts and dominoes. Presentation in a box with double function sliding lid (includes a checked board on its inner side).

16,6 x 3 x 16,5 cm



1



50

D(2), L2, W





1013 **Domis**

Dominoes made of wood. 28 pieces presented in a box with sliding lid.

14,6 x 3 x 5 cm 1/50 100

D(2), L2, W



1016 **Brisca**

Set of 2 table games: French cards and dice. Presentation in a wooden box with two compartments and sliding lid.

10 x 2,5 x 9,1 cm 1/50 100

D(4), L2, W



NEW NAIPES



1028 **Naïpe**

French deck of cards in recycled cardboard. 54 cards included. Presentation in eco design box.

9 x 2 x 6 cm 1/100 200

D(1)





1035 **Pensy**

Wooden noughts and crosses game. Includes 10 pieces presented in a natural cotton pouch.

13 x 12 cm 1/10 500

G(1)



1011 **Triwa**

Noughts and crosses table game made of wood. 9 blocks presented in a box with sliding lid.

7,5 x 3,2 x 7,5 cm 1/50 200

D(4), L2, W



1010 **Ryman**

Game of skill with 45 rectangular blocks, presented in a drawstring cotton bag.

5,7 x 16,5 x 5,7 cm 1 50

G(1), N(8)



1009 **Rocks**

Set of 3 games of skill made of natural wood. Presentation in a wooden box with compartments and sliding lid.

16,5 x 6 x 6,4 cm 1 50

D(4), L2, W



**NEW.****1041 Cubik**

Game of skill set, available in 24 different models.

4 x 4 x 4 cm

24

576

C(1)

CLASSIC GAMES

**0111 Leis**

Tangram puzzle made of natural wood with 7 colour pieces.

10,3 x 10,3 cm

1/100

400

E(1), L2



01

29

03

60

05

226

**0112 Rosko**

Wooden yo-yo with a 75 cm white cord.

2,8 x Ø5,50 cm

1/50

400

C(4), W, L1

8069 **Resol**

Children's drawing set with practical carry handle. Drawing pad, 6 colour pencils, sharpener and rubber included.

20 x 21 x 1,6 cm 1/40 80

D(1)

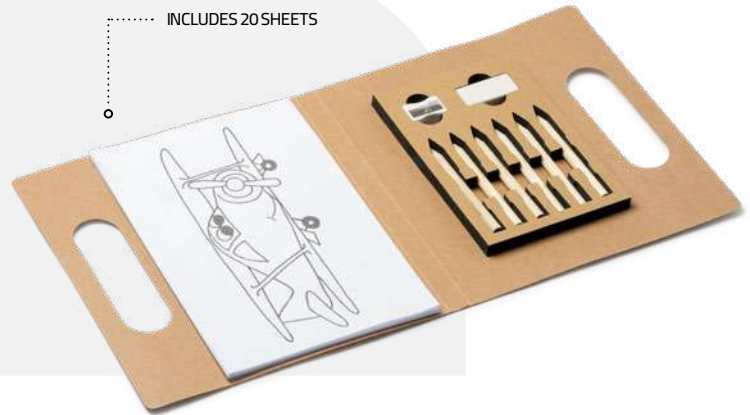

INCLUDES 20 SHEETS

PENCIL SET



03

31

60



05

226

40

02

8047 **Lilian**

Magnetic board with thick marker in different colours. Black felt-tip-pen with eraser included.

10,5 x 15 cm 1/25 200

D(4)



8077 **Pyrus**

Children's drawing set. Drawing pad with 36 sheets with different drawing designs and 12 colour pencils included.

10 x 1 x 9,5 cm 1/50 200

C(4)



36 SHEETS

8049 **Tilos**

Drawing set for kids. Pad with drawings, 6 colour pencils and a sharpener included. Presentation in a recycled cardboard case.

7,4 x 1,5 x 9 cm 1/50 400

C(4), W



COLOURING DRAWINGS



9131 Pachu

Non-woven apron with colouring design for children. 5 crayons in assorted colours included. Adjustable one size.

43 x 43 cm

1/50

200

F(1)



7529 Azor

Non-woven bag with design for colouring. 5 crayons in assorted colours included.

20,5 x 22 cm

1/50

200

F(1)



7530 Turcaz

Non-woven drawstring backpack with design for colouring. 5 crayons in assorted colours included.

25 x 30 cm

1/50

200

G(1)

COLOURS INCLUDED



NEW.



7571 Solaz

Pencil case in non-woven for kids, with design for colouring. 5 crayons in assorted colours included.

22 x 11 cm

1/50

200

F(1)

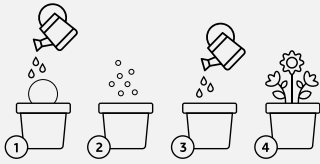

1036 **Girax**

Terracotta flower pot with sunflower seeds. Substrate included. Made in EU.

6 x 5 x 5 cm 1 200
E(1)



MADE IN
EUROPA

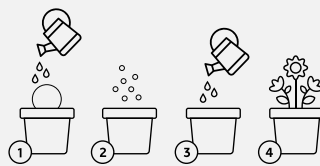

1037 **Tulsy**

Set of two flower pots with parsley and basil seeds. Substrate included. Made in EU.

12 x 5 x 5 cm 1 100
E(1)

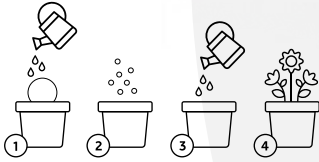

1000 **Volen**

Flowerpot with petunia seeds and biodegradable pot. Soil included.

6,1 x Ø6,40 cm 1/25 200

E(4)



BIODEGRADABLE FLOWERPOT



1314 Citrus

Scent diffuser and humidifier. Steady vaporization with multicolour LED lights. 130 ml capacity. Cable included. Presentation in eco design box.

9,5 x Ø10 cm

1

50

E(1)

CHILL & RELAX



BAMBOO



VANILLA SCENT



1315 Vanila

1315 Vanila

Scented candle in a translucent glass with bamboo lid. Vanilla scent. Presentation in eco design box.

8,8 x Ø7 cm

1

50

E(1), L2



1313 Surna



NATURAL CORK



VANILLA SCENT



1313 Surna

Scented candle in a glass recipient with cork lid. Vanilla scent. Kraft cardboard card for printing included. Presentation in eco design box.

7,6 x Ø5,60 cm

1/25

100

E(1)

SCENT
YOUR HOME
NATURAL FINISHES

CANDLES

FOR HOME

1307 King

Scented candle with ceramic slate recipient. White chalk included. Presentation in a kraft cardboard box.

7,8 x Ø7 cm 1 50

E(1), L1



01 260 60



251 02

1306 Flake

Vanilla scented candle in bright colour presented to match with metallic holder. Lid with transparent window.

3 x Ø6,30 cm 1/50 250

E(1), L1



01 03 31 60
05 226 40 02

1311 Kimi

Scented candle in a colour glass recipient with different scents (coffee, pine, lavender, vanilla and strawberry). Presentation in individual box.

6,7 x Ø5,60 cm 1 50

F(1), L1



512

1312 Maka

Candle with a wooden recipient in two christmas designs (star and tree). Presentation in individual box.

8,7 x 2,1 x 8,4 cm 1/100 200

E(1), L1



511

MOBILE PHONE HOLDERS



BAMBOO

4094 Stelo

Keyring with mobile stand function made of bamboo.

6 x 1,4 x 2,6 cm 1/100 500

D(4), L1, W



BAMBOO

3010 Lyra

Mobile stand in natural bamboo. Lower gap for the charging cable. 2 easy-assembly parts included.

8 x 8,1 x 12 cm 1/50 100

D(4), L2, W



BAMBOO

3055 Antix

Stand for mobiles, tablets or Smartphones made of natural bamboo.

6 x 2 x 8 cm 1/50 200

D(4), L1, W



BAMBOO

4110 Boncer

Natural bamboo keyring with mobile stand function.

8,5 x 2,9 x 0,8 cm 1/100 600

D(4), L1



4109 **Marbel**

Natural wood keyring in two formats with finishing touches in elegant imitation leather.

8,5 x 0,5 cm 1/100 800

D(4), L1



982

983



4054 **Budan**

Natural wood keyring. Perfect for laser engraving.

10,4 x 05 cm 1/200 800

D(4), L1



982

983

6x0,3x3,5 cm

0,5x05 cm



NATURAL CORK

4053 **Hibis**

Natural cork keyring.

3,9 x 8,1 cm 1/200 800

D(1), L1



4x0,5x6 cm

981

0,5x05 cm

982



4092 **Sila**

Natural wood keyring in two designs with metal ring. Ideal for laser printing.

7,2 x 03,90 cm 1/100 1000

D(4), L1



3 x 8,8 x 0,6 cm

03,9 x 0,6 cm



NATURAL CORK

4108 **Yate**

Floating keyring in natural cork with resistant polyester cord.

9 x 1,5 x 4 cm 50 400

D(1), L1



02

05



60 05 226 40 251 02

4070 Sparkling

Aluminium opener keyring

1,1 x 6,7 x 1,5 cm 1/200 1000

D(4), L1



60 05 226 251 02

4071 Stout

Aluminium opener keyring with bottle design.

3 x 8,9 x 0,2 cm 1/100 1000

D(4), L1



31 60 05 226 251 02

4074 Malt

Aluminium opener keyring.

7,9 x 1,5 cm 1/200 1000

D(4), L1



60 05 226 251 02

4207 Bioko

Aluminium opener keyring.

6 x 1,5 x 1,1 cm 1/200 1000

D(4), L1



60

05

226

251

02

4072 Lager

Aluminium opener with classic design.

3,8 x 8,5 x 0,3 cm 1/100 1000

D(4), L1



60

05

226

251

02

4073 Pale

Aluminium carabiner with keyring.

3 x 5,8 cm 1/200 1000

D(1), L1



01

05

226

02

60

4050 Tonic

Keyring coin for shopping trolley. Metallic with coloured enamel.

6 x Ø2,30 cm 1/100 1000

D(1)

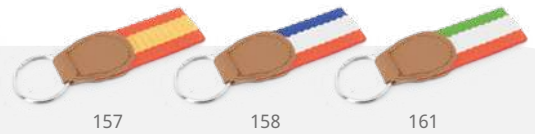

4080 Flag

Polyester keyring with a flag design and PU reinforcement.

12 x 3 cm 1/50 400
E(1), L1



4051 Mineral

Metallic keyring with coloured polyester strap.

2,8 x 6,5 x 0,6 cm 1/50 300
D(4), L1



1004 Tresna

1 metre measuring tape keyring with blocking mechanism and metallic strip hook.

4,3 x 4,4 x 1,8 cm 1/50 500
D(1), V



4079 Sito

Teddy bear keyring with colour t-shirt in soft polyester.

6,5 x 7,5 x 4 cm 1/20 500
E(1), N(8)





1228 **Seyku**

Stress ball made of solid colour PU.

📏 Ø6,20 cm

📦 1/20

📦 400

👤 E(1)

NEW.
COLOR



01



60

ANTI-STRESS

1229 **Biku**

Heart-shaped stress ball made of solid colour PU.

📏 7 x 7 x 4 cm

📦 1/20

📦 400

👤 E(1)



NEW.



60



05

1232 **Dona**

Drop-shaped stress ball in plain colour PU.

📏 8 x Ø6 cm

📦 1/20

📦 400

👤 E(1)

TOOLS & PET CARE



3984 **Sorby**

Multi-tool in stainless steel. Compact design. 11 functions, including screwdrivers and chain tool. Presentation in design box.

9,1 x 1,8 x 4,6 cm 1/20 60

E(1), L2



NEWSORBI



TOOLS SET



4127 **Turner**

Tool set with 20 accessories included: screwdriver handle, interchangeable bits, socket adapter, interchangeable sockets, precision screwdrivers and box cutter.

4,9 x Ø12,90 cm 1 30

F(2)





8024 **Kanchan**

4-in-1 multi-tool ball pen: level, ruler in centimeters and inches, flat screwdriver and star screwdriver. Main body in metal finish, rotating mechanism and metal clip. Blue ink.

14,9 x Ø1 cm 1/50 1000
 B(4)

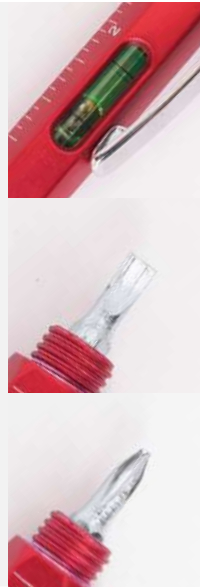

NEW.



3991 **Brico**

Aluminium multi-tool in the shape of a pen. 8 screwdriver heads, star and flat, included.

11 x Ø1,30 cm 1/50 200
 C(1), L1



0108 **Lock**

Cutter with wide blade and ABS body. Ergonomic die-cut grip and removable cap for the cutting and adjustment of the blade.

3 x 15,5 x 1,4 cm 1/100 500
 C(4)



8088 Veta

Oval-shaped carpenter pencil for easy marking. Unsharpened tip.

17,6 x 1,2 cm

100

1000

A(4), L1



8003 Mata

Mini wooden pencil in natural finish with rubber. Round body.

10 x Ø0,50 cm

100

2000

A(4)



PPE

9921 Franklin

Clear anti-fog goggles with temples with side vent openings, made of light polycarbonate.

15,5 x 5,7 x 15 cm

1/10

200

D(4)



01



02

0104 Sherlock

7x fold-out thread counting magnifier with in-built measuring ruler. Presentation in individual box.

4,5 x 4,5 x 1,4 cm

1/50

400

C(4)

SHERLOCK

PICK

RIVET



5M

0106 **Pick**

Approved 5 m flexometer with blocking mechanism and metallic strip hook. Body in colour rubber, metallic clip and carry strap. Presentation in individual box.

7 x 3,5 x 7 cm 1/10 50 E(1)

3M

0105 **Rivet**

Approved 3 m flexometer with blocking mechanism and metallic strip hook. Body in colour rubber, metallic clip and carry strap. Presentation in individual box.

6,5 x 3 x 6 cm 1/10 50 E(1)

WORK ACCESSORIES

NEW.

NEW.



BAMBOO

1026 **Dovel**

5 m flexometer with blocking mechanism and metallic strip hook. Metal clip, carry strap and details in bamboo. Presentation in eco design box.

6,5 x 6,5 x 3,1 cm 1/30 60 E(4), L1

3983 **Dintel**

Aluminium scale in a triangular 30 cm design. 1:20, 1:25, 1:50, 1:75 and 1:100 scales. A flat side, special for marking. Presentation in white box.

32 x 2 x 2 cm 1/50 200 F(4), L1



3 LIGHT MODES



01 60 05 226 02

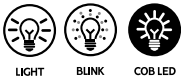

0110 Flash

Sports headlamp with multifunction adjusting strap. 8 COB LED lights with 3 light modes. 3 AAA batteries not included. Presentation in individual box.

6,1 x 4 x 1,7 cm 1/100 500

E(1)



MANUAL CHARGE



03 60 05 226 02

0107 Brill

Flashlight with 3 LED lights and manual charge. Available in different semitransparent colours, with grey carry strap and matching push button. Presentation in individual box.

10,5 x 5 x 2,5 cm 1/25 200

D(4), V

ALWAYS WITH LIGHT



60 05 251 02

8023 Araya

Ball pen with LED flashlight and metallic ABS body. In-built carabiner in cap. Blue ink.

11 x Ø1 cm 1/50 500

B(4)



60 05 251 02

0109 Hale

Aluminium flashlight in metallic finish with 1 LED light. Matching carabiner and button batteries included.

6 x Ø1,50 cm 1/100 600

D(4), L1

3990 **Goliat**



3989 **Vidur**



3988 **Kaide**



NEW
KNIVES



NEW.



NEW.



NEW.



BAMBOO

3988 **Kaide**

Stainless steel jackknife with grip in natural bamboo. Carry strap included. Presentation in eco design box.

9,7 x 2,5 x 1,1 cm 1/10 250

E(4), L1



NATURAL WOOD

3989 **Vidur**

Jackknife in stainless steel and combined grip with natural wood. Safety lock. Presentation in eco design box.

9,1 x 2,4 x 1,4 cm 1/10 100

E(4), L1



NATURAL WOOD

3990 **Goliat**

Stainless steel jackknife with blade in black and grip in natural wood. Safety lock. Presentation in eco design box.

9 x 2,6 x 1,2 cm 1/10 100

E(4), L1



MURDOCK



BAMBOO

4120 **Murdok**

Multipurpose tool with main structure and accessories in stainless steel and bamboo grip. 12 functions: knife, serrated knife, nail files, bottle openers, screwdrivers and pliers. Carry strap included. Presentation in eco box.

 5 x 1,7 x 10,5 cm  1/10  100

 E(4), L1



BINTAI



BAMBOO

4096 **Bintai**

Multipurpose jackknife with accessories in stainless steel and main structure in bamboo. 9 functions. Carry strap in imitation leather included. Presentation in eco box.

9 x 1,6 x 2,3 cm 1/50 100

E(4), L1

..... 9 FUNCTIONS



4095 **Zora**

Stainless steel multipurpose jackknife with 6 functions: knife, bottle opener, can opener, corkscrew, screwdriver and keyring. Presentation in white box.

7,6 x 2,1 cm 1/20 200

E(4), L1

ZORA



..... 9 FUNCTIONS



PINE

OCEAN

BARRIES

LAVANDER

4 COLOURS

DIFFERENT SCENTS



01

60

05

226

1316 Rindal

Air freshener with different scents in a glass recipient with wooden cap and matching adjustable cord. 5 ml capacity. Presentation in a transparent box.

 4,8 x Ø2,30 cm  1/100  400

 D(4)



7169 Rifter

Car trunk organizer in resistant non-woven. Reinforced handles, side handles and front pocket. Rigid base for better adjustment.

 34 x 28 x 25 cm  1  40

 G(1), N(8)



TRAVEL ORGANISER



4128 **Nisek**

Ice scraper glove with 210T polyester lining.

25 x 1,5 x 17 cm /20 100
E(1), N(8)

ICE SCRAPERS



4142 **Alsen**

Ice scraper in a compact design. One serrated edge and two flat ones.

11 x 11,7 x 0,2 cm 50 600
D(2)



4143 **Nosok**

Ice scraper in bamboo with a serrated edge and a plain one.

12,4 x 0,6 x 10,8 cm 1/50 200
E(1)



EN ISO 13688:2013
 EN ISO 20471:2013/A1:2016
CLASS 2

5063 **Sirio**

High-visibility vest with two reflective strips on chest and back. V-neck and adjustable velcro fastening.

CE certificate according to the following standards: UNE-EN ISO 13688:2013/A1:2021 and UNE-EN ISO 20471:2013/A1:2017. Class II.

1 100

SAFETY & PREVENTION

NEW.



5627 **Gante**

Thermal blanket for sports activities. Water and wind-proof. Interior side in aluminium.

210 x 130 cm 1/50 200
 D(1)



SUNSHADES

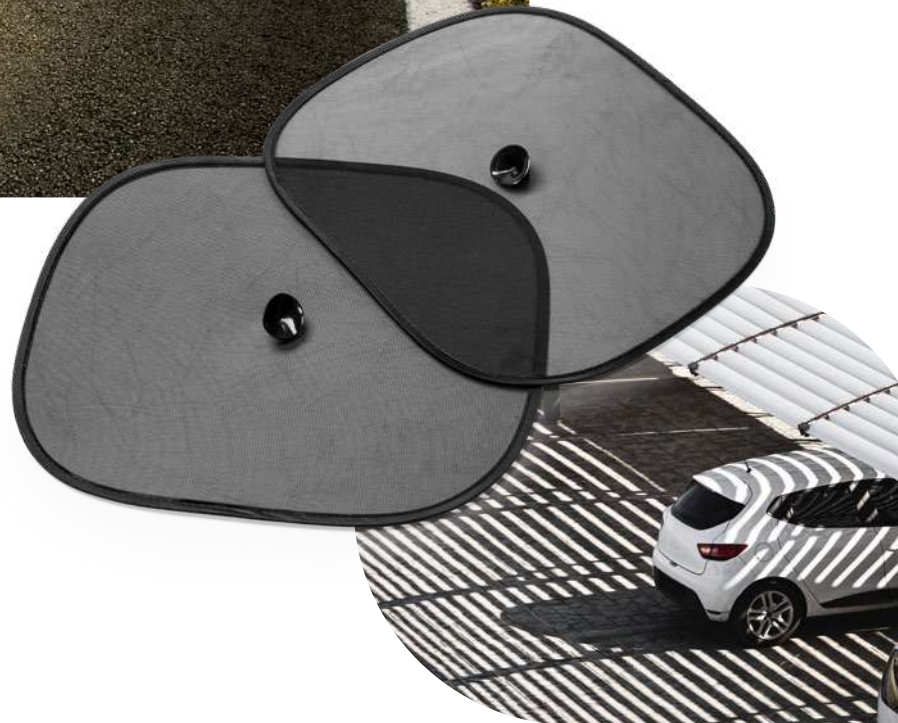

1007 **Mack**

Set of 2 foldable sun shields for car windows. Suction pads included. Presentation in PVC case.

 44 x 38 cm

 1/25

 100

 F(1)

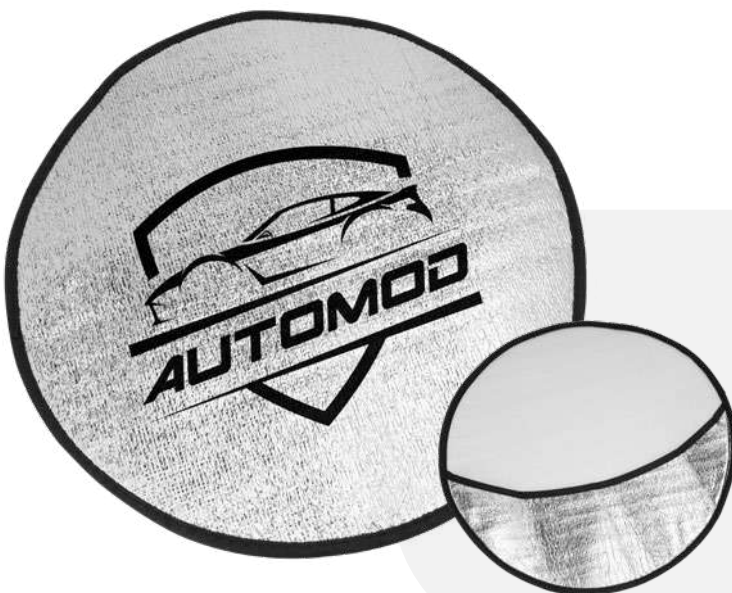

0103 **Bora**

Steering wheel sun shield with front in metallic aluminium. Black edging. Presentation in flat format.

 Ø44 cm

 200

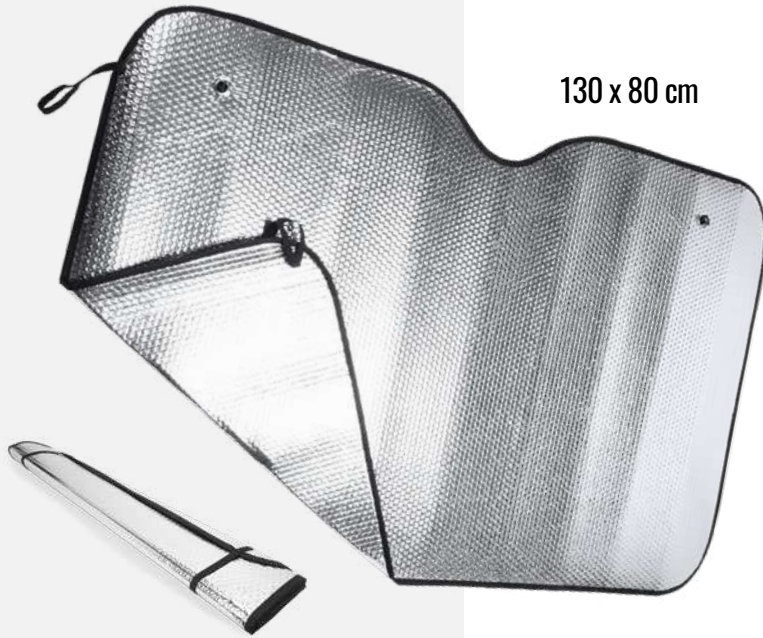

 F(1)



130 x 80 cm

0102 Batur

XL car sun shield with both aluminium sides in a metallic bubble design and polyester edging. Metal eyelets with suction cups and elastic straps for its folding included. Presentation in flat format.

 130 x 80 cm  100
 G(1)





180 x 90 cm



1017 Columbia

Ideal large sun shield for trucks and vans. Both sides in bubble aluminium and black edging. Metal eyelets with suction cups and elastic straps for folding included. Presentation in flat format.

 180 x 90 cm  50
 G(1)

TRUCK SUNSHADE

150 x 70 cm

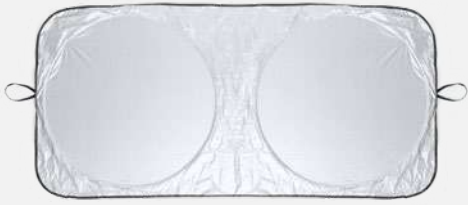

1008 **Prisma**

Foldable sun shield in 170T polyester. Practical matching pouch included.

150 x 70 cm 1/50 100
G(1)



POUCH INCLUDED



130 x 65 cm

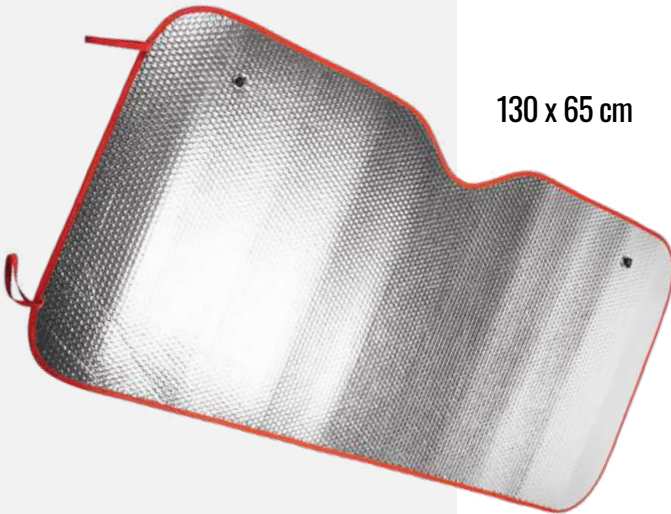

60

05

02

0101 **Kini**

Car sun shield with both aluminium sides in a metallic bubble design and colour edging. Metal eyelets for suction cups and elastic straps for its folding included. Presentation in flat format.

130 x 65 cm 100
G(1)

130 x 60 cm

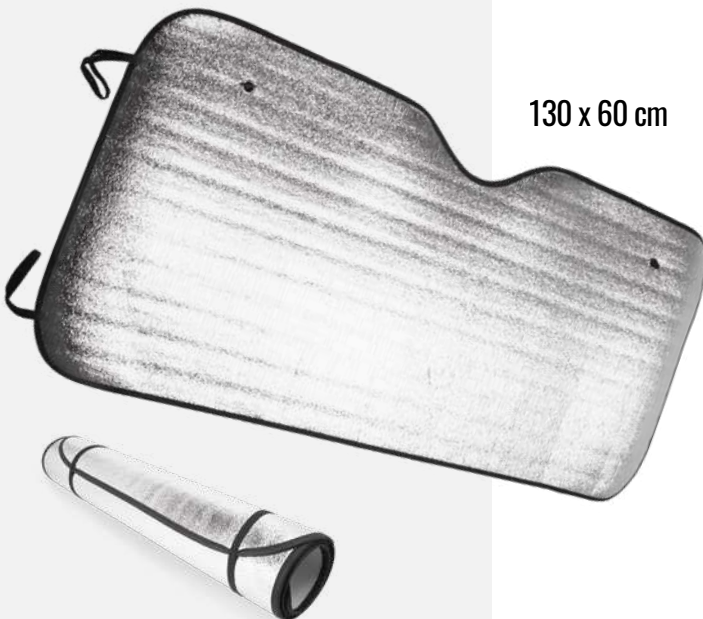

0100 **Akala**

Sun shield with aluminium front in metal finish, polyester trim and reinforced metal eyelets. Suction cups and elastic straps for its folding included. Presentation in flat format.

130 x 60 cm 100
G(1)



60

05

02

1021 **Korat**

Adjustable collar for pets in resistant and soft polyester. Buckle with click fastening. Metal ring for walking leash included.

51 x 2,5 cm

1/20

300

F(1)

PET CARE

THE BEST FOR YOUR PARTNER



01

03

31

60

05

226

02

1018 **Simba**

Pet bag dispenser with matching carabiner. 15 bags included.

8,2 x 4,1 x 5,4 cm 1/50 200

D(4)





60

05

226

1019 Shira

Foldable bowl for pets. Suitable for liquids and solids. 450 ml capacity. Matching metal carabiner included.

📏 5,2 x Ø12,90 cm 📦 1/50 📦 200

👤 L2



NEW.



29



RECYCLED PET

1024 Muntok

Foldable bowl for pets in RPET and recycled paper. Suitable for solids and liquids. 1,3 litres capacity.

📏 10 x Ø17 cm 📦 1/10 📦 200

👤 F(1)



03

60

05

1020 Lanza

Ball for pets in resistant rubber and reinforced fabric.

📏 Ø6,40 cm 📦 1/20 📦 200

👤 N(8), L1



NEW.



01

60

05



RECYCLED PET

1025 Demak

Frisbee for pets with central fabric in RPET and cotton cord.

📏 Ø20 cm 📦 1/10 📦 100

👤 F(1), N(8), R

WINTER & RAINY DAYS

130x165 cm



POLAR FLEECE | SHERPA

GLORY



06

55

47



5626 **Glory**

Sherpa-style blanket in 380 gsm fleece. Card for printing and matching colour ribbon included.

 130 x 165 cm

 1

 10

 F(1), N(8), O, P

100% RECYCLED POLYESTER



5624 Brandon

Fleece blanket made from RPET polyester with practical pouch. Anti-pilling treatment. 200 gsm.

150 x 120 cm 1 20
G(1), H(1), N(8), O, P



BREATHABLE



5622 Bering

Fleece blanket with practical matching pouch in Oxford finish and mesh. Anti-pilling treatment. 100% polyester. 200 gsm.

130 x 160 cm 1 20
G(1), H(1), N(8), O, P



60 05 55 226 58 02



ANTIPILLING

5625 Daneris

Fleece blanket with anti-pilling treatment. Carry handle with velcro fastening included. 100% polyester (200 gsm).

160 x 130 cm 1 25
 F(1), N(8), O, P



31 60 05
 226 58 02



ANTIPILLING

5621 Lambert

Fleece blanket with anti-pilling treatment. 100% polyester. 180 gsm.

120 x 150 cm 1 20
 N(8), O, P





POLAR FLEECE

WATERPROOF



REVERSIBLE



07

15

55

02

6998 Frosty

Reversible bucket hat in nylon and fleece lining.

Ø60 cm

25

100

F(1), N(8), O



PROLY

ANN REFORMS



01

60

55

05

02

9009 Planet

Knitted beanie with double turn-up on hem, ideal to be embroidered. 100% acrylic. Removable label.

10

200

N(8), O, P



06

60

05

55

107

40

58

02

6997 Bulnes

Beanie hat in double-layer polyester. Matching front turn-up, ideal for marking.

22 x 21 cm

1/10

200

E(1), N(8)



9947 **Delun**

Multifunctional neckwarmer in a 150 gsm organic cotton.

25 x 50 cm 1/10 100

G(1), N(8), O, P



2009 **Nukka**

Fleece neckwarmer with elastic adjuster. Wind-proof model. 100% fleece polyester. 210 gsm.

30 x 25 cm 10 100

G(1), N(8), O, P, R



SUBLIMATION



9004 **Nanuk**

Multifunction neckwarmer in a straight-cut and tubular design. 100% cotton touch polyester. 130 gsm.

25 x 50 cm 25 500

G(1), N(8), R



5623 **Zeland**

Touchscreen gloves (thumb, index and middle fingers). Tactile area in different colour from the rest of the glove. One size for adults. Made of acrylic fabric.

21 x 11,5 cm 1/10 200

N(8)



03



60



05

5600 **Damper**

Foldable waterproof poncho with hood and arm openings. Heat-sealed edges and side fastening by clasp buttons. One size (127 x 100 cm). PVC. Pouch included.

22,5 x 18 cm

1

50

F(1), H(1)

RAINY DAYS



01



03



60



05

..... POUCH INCLUDED

5603 **Baikal**

Waterproof raincoat with heat-sealed edges, front fastening with 4 snap buttons, side flap pockets, cuffs with adjusting button, 3 vent holes in the back and an adjustable drawstring hood. One size adults. Pouch included.

86 x 72 cm

1/10

50

F(1)





5602 **Vostok**

Compostable waterproof poncho with hood and arm openings. One size for adults (127 x 102 cm). Made of lactic polyacid (PLA). Presentation in individual PLA pouch.

127 x 102 cm 1/50 200
 E(1)



01 03 60 05 226

5601 **Shaka**

Foldable waterproof poncho for adults with hood and arm openings. One size (127 x 102 cm). Made of low density polythene (LDPE). Presentation in individual pouch.

127 x 102 cm 1/50 200
 E(1)

DISCOVER OSAKA

NEW AUTO-OPENING UMBRELLA



23 55 02

5998 Osaka

190T pongee umbrella with soft touch handle. Auto opening. Wind-proof fiberglass ribs and reinforced tips.

82 x Ø107 cm 1 25

G(1), N(8)



WINDPROOF

5609 Harul

XL 190T polyester umbrella with handle, shaft and tips in black. Long wind-proof fiberglass ribs. Auto-opening button. EVA handle. Matching velcro fastening.

98 x Ø130 cm 1 25

G(1), N(8), R

SUBLIMATION



01 60 55 05 02



SUBLIMATION



Ø105

01 60 05 226 02 0102

5611 **Fargo**

Umbrella made of 190T polyester with wooden handle and auto-opening. Ribs and tips in black. Velcro fastening.

85 x Ø105 cm 1 40
G(1), N(8), R

WOODEN HANDLE



Ø105



01 03 31 60 05 226 02

5608 **Milford**

Umbrella with matching fabric and handle. Ribs and tips in black. Velcro fastening and auto-opening. Made of 190T polyester.

83 x Ø105 cm 1 25
G(1), N(8), R



SUBLIMATION

NEW.
COLOR



Ø105

01 60 55 05 226 02 63

5607 **Lyse**

Umbrella with handle, shaft and tips in wood. Ribs in black. Matching velcro fastening. Manual opening. Made of 190T polyester.

90 x Ø105 cm 1 25
G(1), N(8), R





NEW.



01 55 46 02



5605 Miyagi

Foldable umbrella with automatic opening. 190T pongee fabric with matching pouch. EVA handle and black metal ribs.

☰ Ø98 cm

📦 1

📦 30

👤 G(1), N(8), R

**AUTO
OPEN&CLOSE
UMBRELLA**



01 60 55 02

5999 Nauro

Auto open-close umbrella in 190T pongee with matching pouch. Ribs and tips in black with bamboo handle. Matching velcro fastening.

☰ 57 x Ø100 cm

📦 1

📦 30

👤 G(1), N(8), R





5606 **Yaku**

Foldable umbrella with manual opening and matching pouch. Silver handle, ribs and tips. Velcro fastening. Made of 190T polyester.

24 x Ø5 cm



G(1), N(8), R

SUBLIMATION



NEW.
COLOR



100% RECYCLED POLYESTER

SUBLIMATION



01 60 05 02



5610 **Khasi**

Foldable umbrella in 190T recycled polyester with matching pouch. Shaft, ribs and tips in black. Natural wood handle, velcro fastening and manual opening.

27,5 x Ø5,80 cm



G(1), N(8), L2



WOODEN HANDLE

SUBLIMATION



7618 **Miso**

Tote bag, ideal for sublimation in soft resistant polyester. 70 cm long handles.

 42 x 38 cm

 10

 100

 F(6), N(8), R

POLYESTER WITH COTTON TOUCH



7569 **Osak**

Toilet bag, ideal for sublimation in soft polyester with inner lining. Zip with matching puller.

 22 x 14 x 6,5 cm

 1/25

 500

 F(1), N(8), R



7180 **Kanda**

Drawstring backpack, ideal for sublimation in soft resistant polyester.

 42 x 34 cm

 10

 100

 F(1), N(8), R



7114 **Hamelin**

Drawstring bag in 210D polyester with metal eyelets. Removable label.

34 x 42 cm 50 300
 F(1), N(8), R



7152 **Ninfa**

Drawstring bag in 210D polyester with reinforced corners. Front pocket with zip and cable eyelet. Removable label.

34,5 x 45 cm 10 200
 F(1), N(8), R



7550 **Larus**

Drawstring backpack made from soft 210D recycled polyester with reinforced corners.

34 x 42 cm 50 300
 F(1), R



7154 **Sison**

Compact and light backpack in resistant 600D polyester. Front pocket with vertical opening. Padded back and shoulder straps. Removable label.

23 x 40 x 12 cm 1 50
 F(1), N(8), O, R



7127 **Trento**

80 gsm non-woven bag with resistant die-cut handles and heat-sealed edges. Perfect for sublimation.

34 x 43 cm 20 400
 F(1), N(8), R



7527 **Mito**

Sewn non-woven shopping bag with reinforced handles. Perfect for sublimation. 70 cm long handles.

36 x 40 cm 50/50 250
 F(1), N(8), R



8110 **Cloud**

Glasses pouch with drawstring fastening. Soft touch polyester.

9 x 18 cm 50 1000
 D(1), N(8), R



7549 **Pantala**

Foldable shopping bag made from soft 210T recycled polyester. Practical pocket for folding included.

33 x 46 x 8 cm 20 400
 F(1), G(1), R

7522 **Toco**

Foldable shopping bag in soft 190T polyester in stitched finish. Includes practical elastic band for folding.

42,5 x 38 x 7 cm 1/20 400
 F(1), G(1), H(1), R



800ml

4144 **Magun**

304 stainless steel bottle in solid finish. 800 ml capacity. Presentation in design box.

22,5 x Ø7,40 cm 1 40
F(1), L2, L3, Q

DOUBLE WALL

600ml

4139 **Torke**

Double wall thermos bottle in 304 stainless steel. 600 ml capacity. Presentation in design box.

26 x Ø6,90 cm 1 30
F(1), L2, L3, Q



BAMBOO

DOUBLE WALL

620ml

4039 **Boina**

304 stainless steel and bamboo bottle. 620 ml capacity. Presentation in design box.

21 x Ø7,30 cm 1 50
F(1), L2, Q

700ml

4200 **Selby**

304 stainless steel bottle, special for sublimation. 700 ml capacity. Presentation in design box.

25,7 x Ø7,10 cm 1 40
L2, L3, Q

DOUBLE WALL

500ml

4059 **Copo**

Thermos bottle in 304 stainless steel with double wall, special for sublimation. 500 ml capacity. Presentation in design box.

25,5 x Ø7,30 cm 1 24
L2, L3, Q





4122 **Balax**

Thermos bottle in 304 stainless steel. Double wall with copper vacuum insulation. 550 ml capacity. Presentation in design box.

22,5 x Ø7,40 cm 1 30
F(1), L2, L3, Q



4126 **Fancy**

304 stainless steel thermos bottle. Double wall with copper vacuum. 500 ml capacity. Presentation in design box.

26,3 x Ø7 cm 1 30
F(1), L2, L3, W, Q



4045 **Athletic**

Aluminium bottle with carabiner. 400 ml capacity. Presentation in design box.

17,5 x Ø6,60 cm 1 50
F(1), L2, Q



4049 **Baobab**

Aluminium bottle with carabiner. 800 ml capacity. Presentation in design box.

24,6 x Ø7,30 cm 1 50
F(1), L2, L3, W, Q

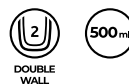

4123 **Salvia**

304 stainless steel thermos bottle with double wall. Glossy finish. 500 ml capacity. Presentation in design box.

24,5 x Ø6,90 cm 1 30
F(1), L2, L3, Q



NEW.



3986 **Adaya**

NEW.



4148 **Puket**



4040 **Camu**



4098 **Kaster**



4060 **Kaffir**



3986 **Adaya**

Frosted borosilicate glass mug, special for sublimation. 500 ml capacity. Presentation in white box.



4148 **Puket**

Frosted borosilicate glass cup, special for sublimation. 330 ml capacity. Presentation in white box.



4040 **Camu**

500 ml glass bottle. Pouch and carry strap in matching colour. Presentation in design box.

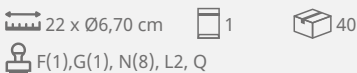

4060 **Kaffir**

340 ml glass mug. Special for sublimation. Presentation in eco box.

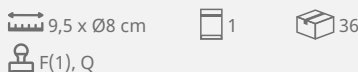

4098 **Kaster**

600 ml glass bottle with colour pouch and carry strap. Presentation in design box.



PREMIUM QUALITY

3999 **Lemon**



350 ml

3999 **Lemon**

High quality ceramic mug, special for sublimation. 350 ml capacity. Individual box not included. Presentation in a 36-unit box.

9,6 x Ø8,20 cm



4000 **Lima**



4003 **Rambu**



4084 **Marang**



350 ml

4003 **Rambu**

350 ml ceramic mug in a matt finish design. Special for sublimation. Presentation in white box.

9,6 x Ø8,20 cm



350 ml

4000 **Lima**

350 ml ceramic mug, special for sublimation. Presentation in white box.

9,6 x Ø8,20 cm



250 ml

4084 **Marang**

250 ml ceramic mug, special for sublimation. Presentation in white box.

8,4 x Ø7,40 cm



700ml

NEW.

3987 **Samui**

Ceramic mug in a glossy finish, special for sublimation. 700 ml capacity. Presentation in white box.

13,8 x Ø10,40 cm 1 20

Q



NEW
SAMUI



0160

0105

0102

300ml

4002 **Kumbo**

Retro style ceramic mug, special for sublimation. 300 ml capacity. Presentation in white box.

8,5 x Ø8,70 cm 1 36

Q

380 ml

4014 **Damasco**

380 ml metal mug, special for sublimation. Vintage style. Presentation in white box

7,9 x Ø8,80 cm 1 48
L2, Q



MAGIC MUGS



350 ml

4085 **Okra**

Ceramic magic mug in matt finish. 350 ml capacity. Pour hot liquids in it and discover the hidden design. Presentation in white box.

9,6 x Ø8,20 cm 1 36
F(1), Q



350 ml

4001 **Mango**

350 ml ceramic mug, special for sublimation. Inside and handle in colour. Presentation in white box.

9,6 x Ø8,20 cm 1 36
Q



0103 0131 0160 0105 01226 0102





Ø105

5611 Fargo

Umbrella made of 190T polyester with wooden handle and auto-opening. Ribs and tips in black. Velcro fastening.

85 x Ø105 cm 1 40

G(1), N(8), R



Ø105

5607 Lyse

Umbrella with handle, shaft and tips in wood. Ribs in black. Matching velcro fastening. Manual opening. Made of 190T polyester.

90 x Ø105 cm 1 25

G(1), N(8), R



Ø105

5608 Milford

Umbrella with matching fabric and handle. Ribs and tips in black. Velcro fastening and auto-opening. Made of 190T polyester.

83 x Ø105 cm 1 25

G(1), N(8), R



WINDPROOF

Ø130

5609 Harul

XL 190T polyester umbrella with handle, shaft and tips in black. Long wind-proof fiberglass ribs. Auto-opening button. EVA handle. Matching velcro fastening.

98 x Ø130 cm 1 25

G(1), N(8), R



Ø95

5606 **Yaku**

Foldable umbrella with manual opening and matching pouch. Silver handle, ribs and tips. Velcro fastening. Made of 190T polyester.

24 x Ø5 cm

1

60

G(1), N(8), R



Ø95



WINDPROOF

5610 **Khasi**

Foldable umbrella in 190T recycled polyester with matching pouch. Shaft, ribs and tips in black. Natural wood handle, velcro fastening and manual opening.

27,5 x Ø5,80 cm

1

50

G(1), N(8), L2



Ø100

5999 **Nauro**

Auto open-close umbrella in 190T pongee with matching pouch. Ribs and tips in black with bamboo handle. Matching velcro fastening.

57 x Ø100 cm

1

30

G(1), N(8), R



Ø98

5605 **Miyagi**

Foldable umbrella with automatic opening. 190T pongee fabric with matching pouch. EVA handle and black metal ribs.

Ø98 cm

1

30

G(1), N(8), R

2998 **Sonic**

XL mouse pad. Soft polyester surface, special for sublimation, and non-slip base. Individual presentation.

 70 x 35 cm

 1/10

 30

 F(1), R

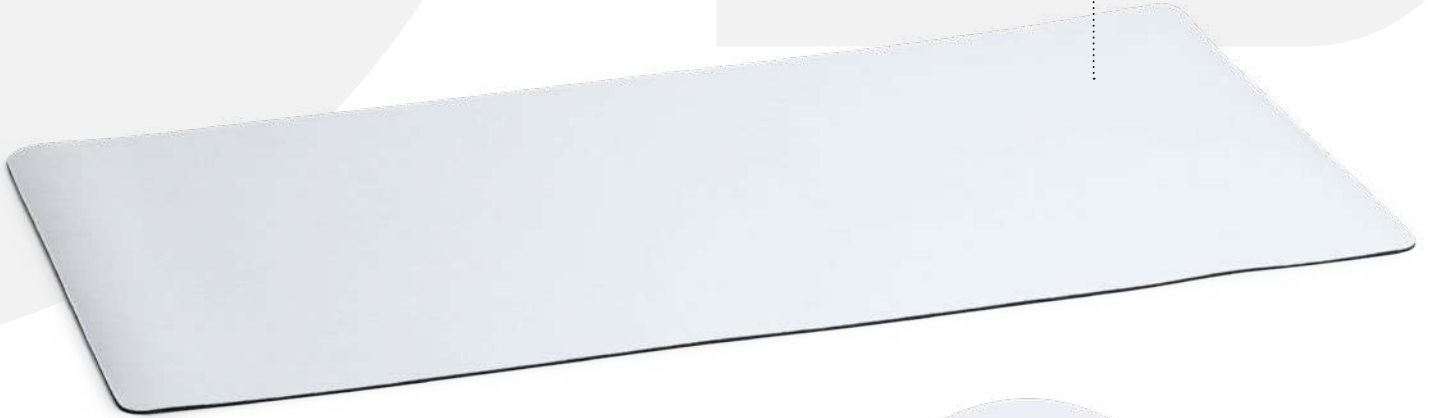

3011 **Sira**

Flat design mouse pad. Soft polyester surface and non-slip rubber base.

 22 x 18 cm

 1/100

 200

 E(1), N(8), R

3012 **Silvano**

Mouse pad made of soft polyester with padded wrist rest. Non-slip rubber base.

 20,5 x 24,3 x 2 cm  1

 100

 E(1), N(8), R



2997 **Yuba**

Round mouse pad. Soft polyester surface and non-slip base.

 Ø20 cm

 1/100

 200

 E(1), N(8), R



3097 **Areta**

Adjustable polyester wristband, special for sublimation.

30 x 1,5 cm  10000



3095 **Spring**

Adjustable polyester wristband, special for sublimation.

30 x 1,5 cm  10000



3096 **Paradis**

Polyester wristband without pressure clasp, special for sublimation.

30 x 1,5 cm  10000



- Sublimation full color included
- Minimum 250pcs



4124 **Kendal**

Keyring with polyester straps, special for sublimation.

12 x 2 cm  2000



7071 **Sinatra**

Double polyester lanyard with carabiner, special for sublimation.

100 x 2 cm  100  500



7049 **Elvis**

Polyester lanyard with carabiner, special for sublimation.

50 x 2 cm  100  500



7050 **Calisto**

RPET cap with 5 panels and embroidered vent eyelets. Velcro fastening.

Ø60 cm 25/75 300
F(1), N(8), O, P, R



7000 **Basica**

5-panel cap with 2 embroidered ventilation eyelets. 4 backstitch lines on peak. Inner sweatband. Velcro fastening at the back.

25 300
Consultar



7048 **Wizer**

Sports polyester visor with velcro fastening and padded sides.

25 200
F(1), N(8), O, P, R



7020 **Mercury**

Technical 3-panel cap. Light and breathable fabric. Adjustable velcro fastening. 90% polyester and 10% elastane (40 gsm). Removable label.

25 200
F(1), N(8), O, P, R



7057 **Kelsey**

Absorbent towel in 185 gsm microfibre. Carry stow pouch with adjustable fastening included.

100 x 50 cm 1 100
G(1), N(8), O, P, R



7103 **Bay**

Absorbent towel made of 345 gsm microfibre. Reusable PVC pouch included.

45 x 30 cm 1 100
F(1), N(8), O, P, R



7119 **Cork**

Multi-sport microfibre towel with practical elastic strap for easy folding. Quick dry. 90% polyester and 10% polyamide (190 gsm). Removable label.

70 x 120 cm 10/10 100
F(1), N(8), O, P, R



9001 **Crossfitter**

Sports hair band in technical breathable fabric. 100% polyester. 140 gsm.

22,5 x 8 cm 10/10 300

G(1), N(8), R



7104 **Olympia**

Elastic sports headband made of soft microfiber, available in an assorted colour selection.

23,5 x 6 cm 1/100 800

G(1), N(8), R



7105 **Speed**

Elastic wristband made of soft microfiber with zip pocket.

10 x 9 cm 1/100 1000

E(1), N(8), R



9129 **Ducasse**

Long apron with double front pocket and matching tie-straps. 90% polyester and 10% cotton (150 gsm). Removable label. One size. Pocket measures: 25 x 16 cm.

65 x 90 cm 10/10 100

Consultar



9134 **Roger**

White polyester kitchen mitt with colour edging and hanging strap. Flat side ideal for sublimation.

19 x 30,5 cm 1/50 200

E(1), N(8), R

PARTY & EVENTS

LEVY NATURAL HAT



29



02

7014 **Levy**

Quality synthetic fibre hat with comfort inner sweatband.



25



100

 Consultar



7060 **Dusk**

Polyester hat.

📦 25 📦 200
👤 F(1)



7015 **Beloc**

Synthetic hat with comfort inner sweatband.

📦 25 📦 100
👤 Consultar



7018 **Jones**

Synthetic wide-brimmed hat with comfort inner sweatband.

📦 25 📦 100
👤 Consultar



CUSTOMIZABLE BANDS

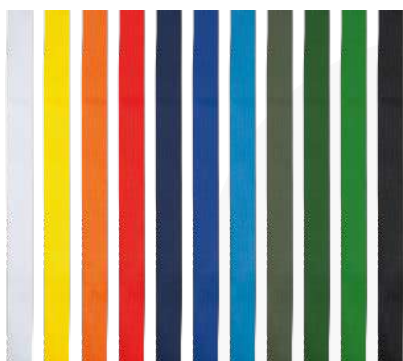

01 03 31 60 55 05 242 13 56 226 02

7013 **Comet**

Non-woven band for hats.

📏 67 x 2,7 cm 📦 10/500 📦 5000
👤 Consultar

STRAW HATS

7062 **Halley**

Natural straw hat with comfortable sweatband.

 250

 Consultar



7061 **Sun**

Natural straw hat with comfortable sweatband.

 250

 Consultar



29



13

7063 **Galaxy**

Natural straw hat with comfortable inner sweatband.

 250

 Consultar



NEW.

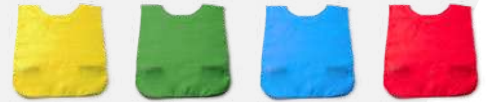

03

226

05

60

9322 **Dalic**

Sports pinnie in 190T polyester. Side elastic straps with velcro fastening.

63 x 52 cm

1/25

300

F(1)

NEW
DALIE

9003 **Festero**

Triangular scarf in soft 60 gsm polyester. White colour ideal for sublimation. One-size.

100 x 70 x 70 cm

100

1000

E(1), N(8), R



3101 **Carnival**

Classic whistle with hanging strap.

1,9 x 2,4 x 5 cm

10/250

1000

C(1)

NEW.



NEW.
COLOR



3106 Jamboree

Set of two inflatable and reusable cheer batons in LDPE. Inflating valve included.

61 x Ø10 cm 1/25 500
G(1)



3109 Suport

Set of inflatable and reusable cheer batons in LDPE. Assorted flag designs. Inflating valve included.

61 x Ø10 cm 1/25 500
G(1)

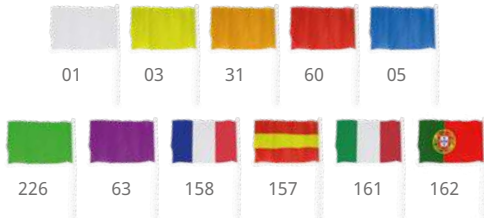

3103 Celeb

Small flag in 170T polyester, available in plain colours and country banners.

21 x 14 cm 10 2000
D(6)



3105 Revel

Two-colour clapper in the shape of a hand.

18,5 x 8,5 cm 1/100 200
E(4)

NEW.



3112 **Milos**

Hand fan with wooden ribs and RPET fabric. Presentation in eco box.

 42,5 x 23 x 3 cm  1/25  250

 D(1), E(2), L1



NEW FANS

NEW.



3113 **Zante**

Hand fan with wooden ribs and cotton fabric. Presentation in eco box.

 42,5 x 23 x 4 cm  1/25  200

 D(1), E(2), L1



3110 **Albero**

Fan with plastic ribs and polyester fabric. Presentation in white box.

43 x 23 cm 1/25 250
 D(1), E(2)

NEW.
 COLOR



3111 **Calesa**

Hand fan with wooden ribs and polyester fabric. Presentation in white box.

42,5 x 23 cm 1/25 250
 D(1), E(2), L1



NEW.



3114 **Keros**

Hand fan with wooden ribs and multicolour fabric. Presentation in white box.

42,5 x 23 x 3 cm 1/25 250
 D(1), E(2), L1

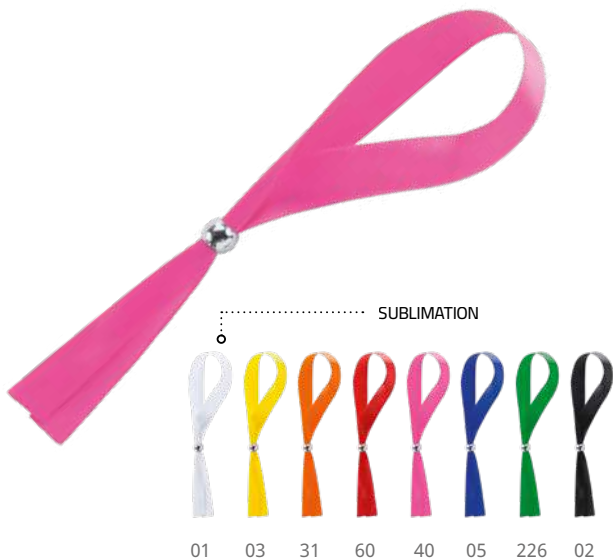

3102 **Fete**

Adjustable bracelet in polyester.

34,5 x 1,2 cm 50/500 2000

D(1), R



3098 **Orbit**

Natural cotton wristband with bamboo pressure clasp (non-transferable).

35 x 1,5 cm 100 2000

D(1)

FOR ALL
EVENTS



3094 **Drilo**

Wristband for events in synthetic fibre with individual numbering. Presentation in 20-unit sheet.

25,4 x 1,9 cm 1000 20000

A(1)

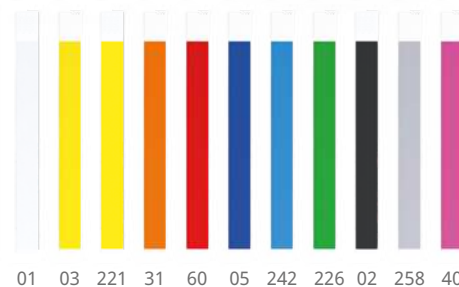

3100 **Party**

Synthetic fibre wristband for events with individual numbering. Presentation in 10-unit sheets.

25,8 x 2,7 cm 10/1000 20000

A(1)

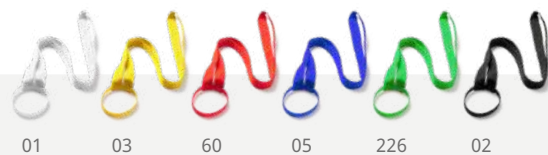
**NEW.**

01 03 60 05 226 02

7047 Aldaz

Cup lanyard holder with adjustable silicone band.

45 x Ø6 cm 10 1000

F(1), N(8), R

500ml

4210 Pontal

Reusable cup in resistant ductile PP. 500 ml capacity.

11,6 x Ø9,2 cm 25 500

C(1)

NEW.**NEW.**

01 60 05 226 02

7046 Dalvik

Silicone lanyard with holder for mobiles or cards, adjustment system and carabiner.

58 x 7 cm 10 300

G(1)



NEW.



7043 **Sumba**

Lanyard with retractable accessory. Carabiner included.

55 x 1 x 3,2 cm 10 500
 D(1), G(1), N(8), R, V



4209 **Doki**

Rollerclip keyring with carabiner and retractable ring.

12,5 x 1,5 x 3,2 cm 1/100 800
 C(4), V

NEW.



SUBLIMATION



7054 **Guest**

Polyester lanyard with carabiner, buckle and security fastening.

2 x 55 cm

10/100 600

F(1), N(8), R

CHOOSE YOUR LANYARD



29

7044 **Nela**

Cotton lanyard with carabiner, buckle and safety fastener.

52 x 2 cm

10

500

F(1), N(8)



NEW.

100% COTTON



7052 **Roomer**

Cotton lanyard with carabiner.

2 x 50 cm

10/100

800

F(1), N(8)

100% COTTON

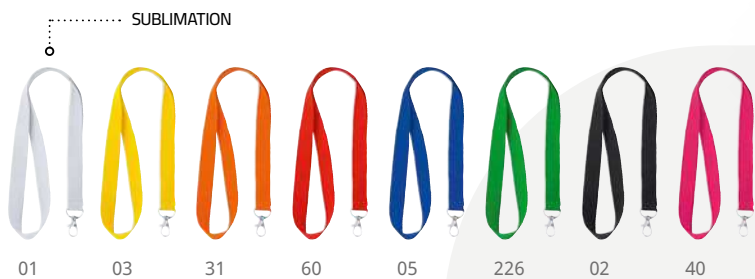

01

03

31

60

05

226

02

40



7055 **Ecohost**

RPET lanyard with carabiner.

2 x 50 cm

10/100

800

F(1), N(8), R

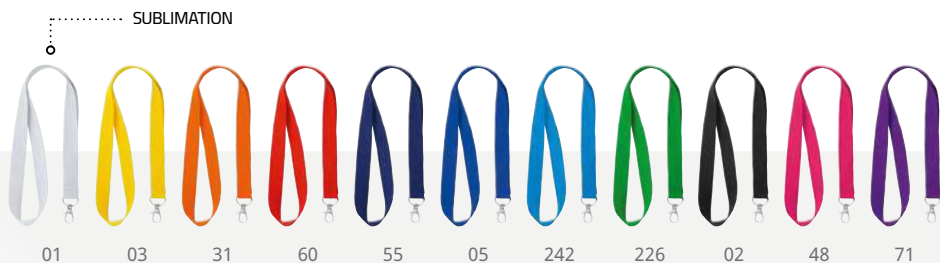

01

03

31

60

55

05

242

226

02

48

71



7053 **Host**

Polyester lanyard with carabiner.

2 x 50 cm

10

800

F(1), N(8), R

NEW.**7045 Pomel**

Lanyard with matching carabiner and PVC badge holder.

58 x 11 cm

10

1000

B(1), F(1)

NEW.**7068 Tabor**

Transparent PVC badge holder in a vertical design.

12,1 x 8,4 cm

200

2000

C(1)

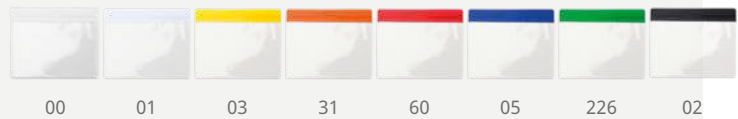
**7070 Bash**

PVC badge holder.

11 x 9,5 cm

10/100

1000

C(1)

NEW.**7069 Ganda**

Badge holder with aluminium front. Double clousure safety pin.

6,8 x 3,4 cm

1/100

1000

C(4), L1



100% CUSTOMIZABLE ON REQUEST



MINIMUM 250PCS



4124 **Kendal**

Keyring with polyester straps, special for sublimation.

 12 x 2 cm



7071 **Sinatra**

Double polyester lanyard with carabiner, special for sublimation.

 100 x 2 cm



7049 **Elvis**

Polyester lanyard with carabiner, special for sublimation.

 50 x 2 cm

SUBLIMATION FULL COLOR INCLUDED



3097 **Areta**

Adjustable polyester wristband, special for sublimation.

 30 x 1,5 cm



SECURITY CLASP

3095 **Spring**

Adjustable polyester wristband, special for sublimation.

 30 x 1,5 cm



3096 **Paradis**

Polyester wristband without pressure clasp, special for sublimation.

 30 x 1,5 cm

SUMMER

NEW BARI

RPET TRANSLUCENT SUNGLASSES



01

60

05



226

02



RECYCLED
PET

8105 Bari

Classic sunglasses in a translucent finish design. UV400 protection.

 14 x 4,5 cm

 1/10

 300

 D(2)

NEW.





8104 **Eden**

Appealing sunglasses with gloss finish frame and natural bamboo temples. UV400 protection lenses.

14,5 x 5 cm 1/10 300

D(2), L1



245

248

257



237

999

8102 **Dax**

Sunglasses with classic design in wood effect finish with UV400 protection.

14,5 x 4,9 cm 1/10 300

D(2)



SUBLIMATION

01

03

31

60

05

226

02

40

8110 **Cloud**

Glasses pouch with drawstring fastening. Soft touch polyester.

9 x 18 cm 50 1000

D(1), N(8), R





8100 **Brisa**

Sunglasses with classic design in gloss finish and UV400 protection.

14,5 x 4,9 cm 1/10 300 D(2)



8103 **Ariel**

Sunglasses with frame in matt finish and UV400 protection lenses.

14,5 x 5 cm 1/10 300 D(2)



8101 **Ciro**

Sunglasses with classic design in matt black finish and mirrored lenses. UV400 protection.

14,5 x 4,9 cm 1/10 300 D(2)



7096 **Denia**

100% 180 gsm cotton towel/sarong.

180 x 90 cm 1 50

F(1), N(8), O, P

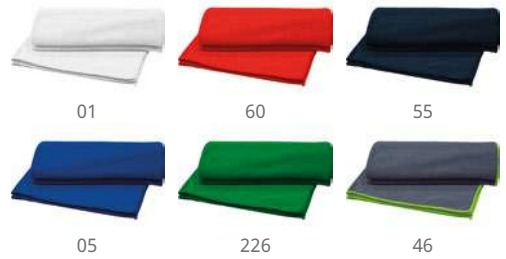

7100 **Orly**

Beach towel in a two-colour design with practical elastic strap for easy folding. 80% polyester and 20% polyamide (280 gsm).

S 38 x 68 cm 10 100
 M 60 x 145 cm 10 50
 F(1), N(8), O, P, R



2SIZES



01

96

60

55

05

226

02



6999 **Bobin**

100% cotton bucket hat.

32 x Ø60 cm

50

200

F(1), N(8), O, P



01

03

31

60

40

05

226

02



8150 **Kalay**

Beach flip flops with comfortable PE sole and PVC straps. Sizes 36-38 and 42-44.

26 x 1,3 x 9,5 cm

10

60

D(1), E(1)

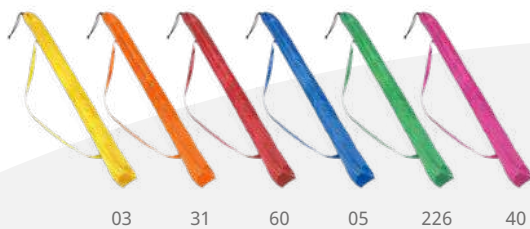

03

31

60

05

226

40



1006 **Skye**

8-panel beach umbrella made of nylon with inner UV protection and piping in flaps. Carry pouch with shoulder strap included.

100 x Ø155 cm

1

12

H(1), N(8)

UVPROTECTION



1022 **Calon**

Classic frisbee in resistant PP.

1,8 x Ø23 cm 1/100 200
D(1)

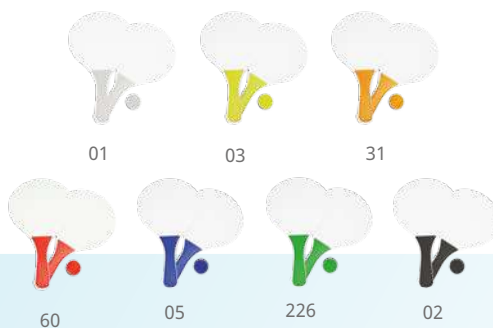

1003 **Feroe**

Wooden beach rackets with reinforced colour handle. Matching ball included. Presentation in a mesh bag.

18,5 x 33 x 0,6 cm 1 30
F(1)



2150 **Saona**

PVC inflatable ball. Flat: 37 cm. Inflated: 28 cm.

Ø28 cm 10/100 200
F(1), G(1)



6L

4121 **Kinto**

Metal bucket with handle. Aluminium bottle opener included. 6 litres capacity.

18,5 x Ø23 cm  1  20

 G(1)



NEW.

NEW LAMBIC



01

60

05



226

02

6L

4208 **Lambic**

Metal colour bucket with aluminium bottle opener included. 6 litres capacity.

18,5 x Ø23 cm  1  20

 G(1)

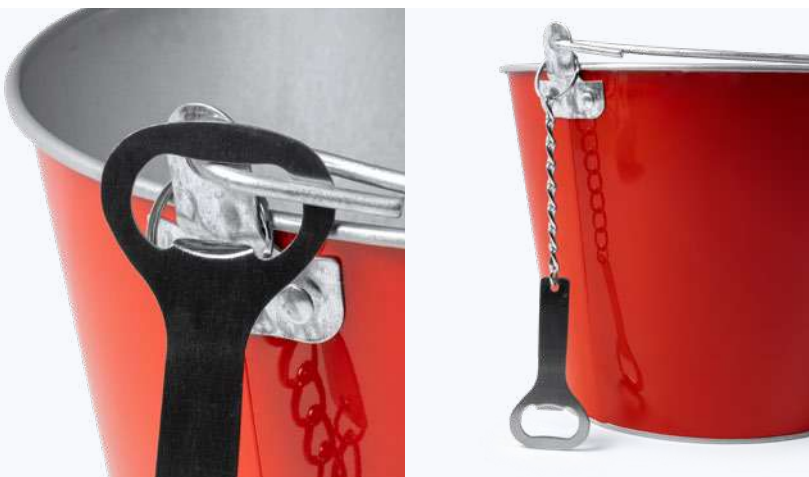



8202 **Eider**

Waterproof multipurpose dry bag in PVC, suitable for touch screens.

9,5 x 23 cm 1/50 500
E(1)



1023 **Cenix**

Pocket ashtray with interior in fireproof aluminium. Flap with clasp button fastening.

8 x 1,1 x 8 cm 1/50 500
C(1)



8205 **Lanka**

Large waterproof dry bag in PVC, suitable for touch screens.

12,5 x 23 cm 1/50 300
E(1)



DRY BAG



01 60 05

2,5L

7531 Aleta

Waterproof dry bag made of resistant ripstop with window pocket for the mobile phone. Watertight fastening system with click and carry carabiner. 2,5 litres capacity.

29,5 x Ø11,5 cm 1/10 200

F(1)



01 60 05

5L

7532 Monje

Waterproof dry bag made of resistant ripstop. Watertight fastening system with click and carry carabiner. 5 litres useful capacity. 8,5 litres total capacity.

35 x Ø18 cm 1/10 100

F(1)



60 05 02

10L

7533 Manati

Waterproof dry bag made of resistant ripstop. Watertight fastening system with click. Carabiner and adjustable shoulder carry strap. 10 litres useful capacity. 15 litres total capacity.

45,5 x Ø20,5 cm 1/10 100

F(1)

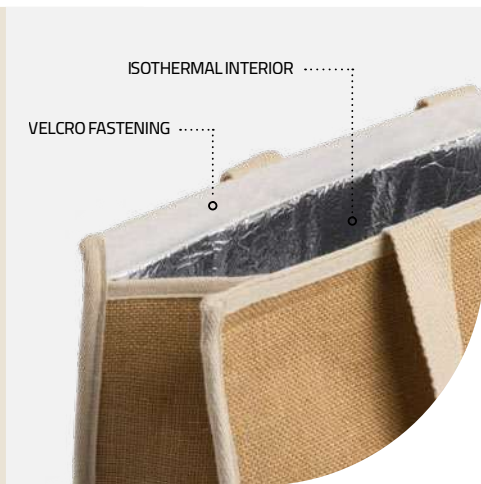

ISOTHERMAL INTERIOR

VELCRO FASTENING

7161 Venice

Cooler bag in laminated jute. Isothermic aluminium lining and velcro fastening. Front pocket and natural cotton handles.

43 x 20 x 34 cm 10 40

F(1), N(8)

NEW.



03 60 05 226 02

7197 Lubin

Foldable cooler bag in 190T polyester. Isothermal aluminium lining and zip fastening. Reinforced handles. Easy folding with zip.

45 x 36 x 9 cm 1/20 100

G(1)



01 31 60 05 226

7603 Tibu

Cool bag with lining in isothermal aluminum for 6 cans. Resistant PVC exterior. Matching carry handle and zip fastening.

21 x 15 x 15 cm 1/25 200

F(1), N(8)

NEW.



7088 Sakra

Cooler backpack in 210D ripstop polyester. Isothermal lining in main and front pockets. Front elastic bungee cord compartment and side mesh pockets. 20 litres capacity. Padded back and shoulder straps.

26 x 40 x 19 cm 1 10
G(1), N(8)



NEW.



7089 Lombok

Cooler backpack in RPET. Isothermal lining in main compartment and pocket in flap. Side mesh pockets. 19 litres capacity. Padded back and shoulder straps.

30 x 43 x 15 cm 1 20
G(1), N(8)

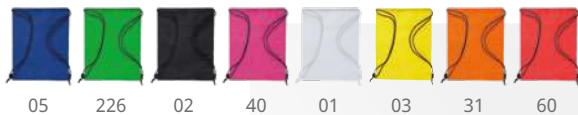

7604 Graja

Cooler drawstring bag with isothermal aluminium lining. Shell in 210D polyester.

32 x 42 cm 1/10 200
F(1), N(8)



LEISURE & SPORT



60

05

02

7095 **Vulcan**

Foldable trekking pole set in aluminium with shock absorption. Ergonomic grip and adjustable security strap. Snow accessory included. Reinforced ground contact surface. Presentation in practical carry bag with shoulder strap.

140 x Ø cm

1

20

G(1), L2, N(8)

3 ACCESSORIES





7093 **Regina**

Cotton skipping rope with smooth wooden handles. Presentation in cotton pouch.

280 x Ø2,70 cm 1 50

D(1), L2, N(8)



FITNESS MOOD



7094 **Rocky**

Adjustable technical skipping rope. Drawstring pouch included.

300 x 14,5 cm 1 100

G(1), N(8)



7097 **Emon**

Set of elastic bands for fitness with different resistance levels. Polyester pouch.

 9 x 21 cm

 1/20

 100

 F(1), N(8)



HIGH INTENSITY

SOFT

MEDIUM

HARD

3 LEVELS



YOGA LOVED

CARRY POUCH



60

05

02

7102 Chakra

Yoga mat with practical carry pouch. Light, resistant and non-slip surface.

 180 x 60 cm

 1

 20

 G(1), K(1)



NEW AURA

NEW.



NATURAL
CORK

7092 **Aura**

Yoga mat in natural cork, with anti-slip base and carry strap.

 60 x 180 cm

 1

 10

 G(1), N(8), L2





NEW.



03

60

05

226

9322 **Dalic**

Sports pinnie in 190T polyester. Side elastic straps with velcro fastening.

63 x 52 cm

1/25

300

F(1)

SPORT ACCESSORIES

NEW.



01

60

05

02

2151 **Tuchel**

Size 5 football in imitation leather. Two-colour design.

Ø21,50 cm

1

40

G(1)



NEW.



3093 Yuma

Auto-adjustable high-visibility wristband in PVC.

30 x 2,9 cm 1/50 1000

D(1)



REFLECTIVE BAND



POCKET



01 03 60 05 226 02

7105 Speed

Elastic wristband made of soft microfiber with zip pocket.

10 x 9 cm 1/100 1000

E(1), N(8), R



22102 7802 22302 02221 02221

7118 Marathon

Multifunctional sports belt in elastic waterproof fabric. High-visibility zip and cable eyelet. 100% polyester. Removable label.

23 x 5,5 cm 10/10 200

N(8)

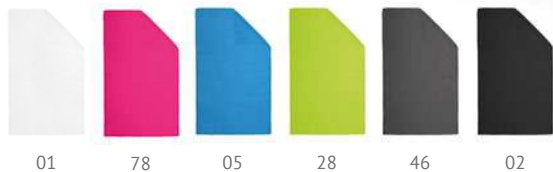

7119 **Cork**

Multi-sport microfibre towel with practical elastic strap for easy folding. Quick dry. 90% polyester and 10% polyamide (190 gsm). Removable label.

70 x 120 cm 10/10 100

F(1), N(8), O, P, R

STOWAWAY POUCH



SUBLIMATION



7103 **Bay**

Absorbent towel made of 345 gsm microfibre. Reusable PVC pouch included.

45 x 30 cm 1 100

F(1), N(8), O, P, R



7101 **Calpe**

Refreshing microfibre towel. Presentation in a practical case with carabiner.

13 x 5,4 x 3 cm 1/50 200

G(1), N(8)



CARRY POUCH



7057 **Kelsey**

Absorbent towel in 185 gsm microfibre. Carry stow pouch with adjustable fastening included.

100 x 50 cm 1 100

G(1), N(8), O, P, R

CROSSFITTER



9001 Crossfitter

Sports hair band in technical breathable fabric.
100% polyester. 140 gsm.

22,5 x 8 cm 10/10 300

F(1), N(8)

OLYMPIA

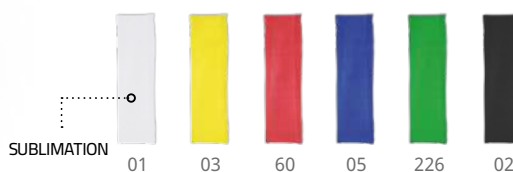

7104 Olympia

Elastic sports headband made of soft microfiber, available in an assorted colour selection.

23,5 x 6 cm 1/100 800

G(1), N(8), R

WIZER



SUBLIMATION



7048 Wizer

Sports polyester visor with velcro fastening and padded sides.

F(1), N(8), O, P, R 25 200



NEW KARIN

NEW.



01 60 05 55 02

7026 Karin

Breathable sports cap in 100% microfibre, with 6 panels. Adjustable buckle fastening and vent eyelets. Removable label.

25 200
 F(1), N(8), O, P, R

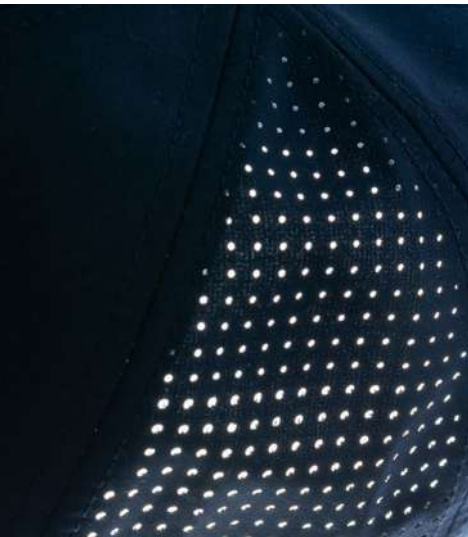

01 221 234 05 02

7020 Mercury

Technical 3-panel cap. Light and breathable fabric. Adjustable velcro fastening. 90% polyester and 10% elastane (40 gsm). Removable label.

25 200
 F(1), N(8), O, P, R

NEW.



221



223

7033 Balder

5-panel cap in 100% polyester with high-visibility details. Adjustable velcro fastening and vent eyelets. Removable label.

 25
  200
 F(1), N(8), O, P

**NEW.**



01



55

7023 Iberis

5-panel cap in 100% combed cotton. National flag design. Adjustable velcro fastening and vent eyelets. Removable label.

 25
  200
 F(1), N(8), O, P



100% RECYCLED PET



7000 **Basica**

5-panel cap with 2 embroidered ventilation eyelets. 4 backstitch lines on peak. Inner sweatband. Velcro fastening at the back.

25 300

Consultar



7050 **Calisto**

RPET cap with 5 panels and embroidered vent eyelets. Velcro fastening.

25/75 300

F(1), N(8), O, P, R



NEW.

NEW FREYA



100%
COTTON

7030 Freya

5-panel cap in 100% cotton. Adjustable velcro fastening and vent eyelets. Removable label.

Ø59,00 cm

30

300

F(1), N(8), O, P



NEW.



ORGANIC COTTON



7024 **Tarvos**

5-panel cap in 100% organic cotton. Adjustable velcro fastening and vent eyelets. Removable label.

25 200
F(1), N(8), O, P



01



05



226



02



7009 **Fides**

5-panel cap in 100% recycled cotton. Adjustable velcro fastening and vent eyelets. Removable label.

25 200
F(1), N(8), O, P

NEW.



Kids



01

Kids



03

Kids



60



55



05

Kids



226



02

7041 **Uranus**

5-panel cap. 100% cotton. 170 gsm. Adjustable velcro fastening and embroidered vent eyelets. Removable label.

25 300
F(1), N(8), O, P



7012 **Terra**

Casual 6-panel cap. Interior of the peak in contrast with the sweatband. Metal eyelets and adjustable fastener. 100% cotton. 260 gsm. Removable label.

25 200
F(1), N(8), O, P



7008 **Panel**

6-panel cap. 100% cotton. Contrasting sandwich. 6 vent eyelets and adjustable velcro fastening. Removable label.

25 200
F(1), N(8), O, P



7019 **Eris**

5-panel cap with contrasting sandwich and four embroidered vent eyelets. Adjustable velcro fastening and removable label. 100% cotton. 170 gsm.

25 200
F(1), N(8), O, P



PERSONAL CARE

NATURAL
CORK

NEW.

1126 **Podox**

Manicure kit with cork case and snap fastener. Stainless steel scissors, tweezers, nail clippers, file and cuticle trimmer included.

11 x 6 x 2 cm 1/50 200

E(1), L1, N(8)



PEDICURE ACCESSORIES



NEW.

1125 **Velvet**

Manicure kit in a drawstring cotton pouch. Nail file and clipper included.

12 x 7,8 cm 1/50 400

F(1), L1, N(8)





NEW.



NEW.

BAMBOO



BAMBOO



BAMBOO



1215 **Rizo**

Natural bamboo comb with handle. Presentation in eco design box.

 3,5 x 18,4 x 0,6 cm

 1/100  500

 C(4), L1

1214 **Kurly**

Natural bamboo comb. Presentation in eco design box.

 13,8 x 3 x 0,6 cm  1/100  500

 C(4), L1





1231 Belle

Folding double-sided pocket mirror made of natural cork and chrome plated metal. 1x/2x magnifying mirror. Presentation in eco design box.

2 x Ø6,10 cm 1/50 200

C(4), L1, W



1220 Glaze

Practical folding pocket mirror with translucent PP shell.

0,5 x Ø6 cm 1/50 500

C(4), W

1223 Liner

1x/2x magnifying double-sided mirror, with soft PU shells and magnetic clasp.

0,9 x Ø7 cm 1/50 300

C(4), L1, W

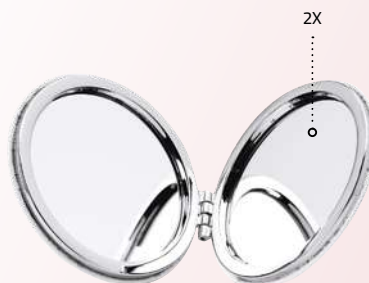

1221 Blunt

Practical folding brush with pocket mirror in a solid design, made of PP.

2,3 x Ø6,60 cm 1/50 200

C(4)



251



281



260

NEW.

1216 Dumai

Practical detangling hairbrush in a glossy finish design.

6,7 x 4,5 x 9 cm 1/50 200

D(1)

BEAUTIFUL PURSES

NEW.



251



281



260

7570 Mauve

PU purse in a glossy finish design, with matching zip and puller.

12 x 8,5 x 0,5 cm 1/10 1000

D(1)



251



49



260

1225 **Beiso**

Lip balm in a sphere-shaped recipient with a chrome plated finish. SPF15 protection.

Ø3,80 cm

1/50

500

C(1)



LIP BALMS



1230 **Lapp**

Lip balm in a classic stick case format made of wheat fiber. SPF15 protection.

7 x Ø1,90 cm

1/25

500

C(1)



01



03



31



60



40



05



226

1124 **Lissen**

Lip balm in a classic stick format in semitransparent finish. SPF15 protection.

7 x Ø1,90 cm

1/25

500

C(1)



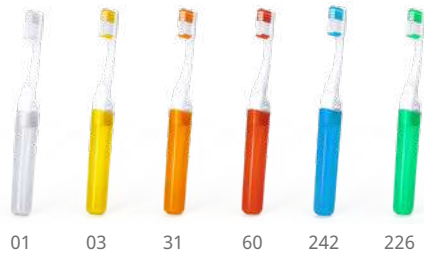

9924 **Pole**

Foldable PP toothbrush ideal for travel, with matching soft bristles.

17,5 x 2,3 x 1,5 cm

1/50

500

C(1), W

CHOOSE
YOUR
COLOR



9944 **Clive**

Toothbrush for children in bright colours and soft touch design, with suction pads on the base.

14,5 x 1,5 x 2,7 cm

1/50

500

F(1), L1



03

31

60

05

226

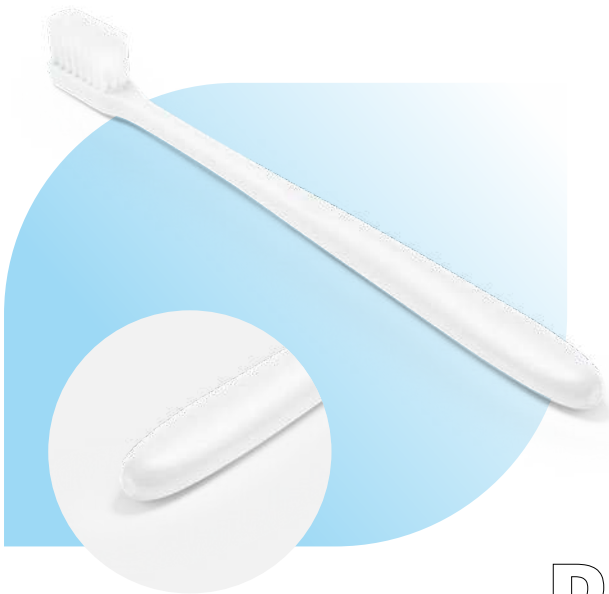

9945 **Kora**

Toothbrush with body in PLA. Soft white bristles. Presentation in eco design box.

18,4 x 1,6 x 1,4 cm

1/100 600

C(1)



9923 **Fresh**

ECO-line toothbrush made of bamboo, with white plastic bristles. Soft hardness type. Bamboo without BPA additives, 100% biodegradable. Presentation in kraft design box.

17,5 x 1,6 x 1,3 cm

1/50 400

C(4), L1

BIO DEGRA DABLE



FUNNY TOOTHBRUSH



9946 **Mesler**

Toothbrush set with sand clock. Toothbrush in colourful fun design and soft touch, with suction pads on the base. 2-minute sand clock. Presentation in individual air-tight seal case.

19,5 x 8,5 x 2,5 cm

1/10 200

F(1), L1

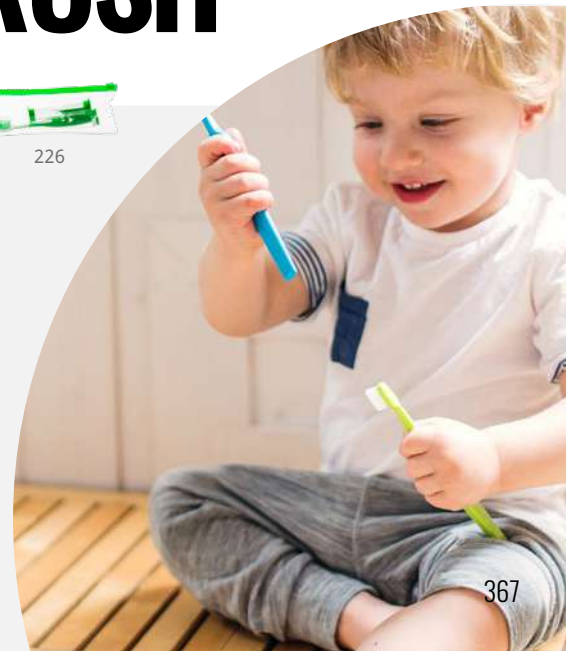



9919 **Nobel**

Single-use and compostable hydroalcoholic sanitizing wipe with 70% alcohol in an individual heat-sealed satchet.

📏 5,7 x 8 cm 📦 1/100 📦 3000
 🗑️ A(1)



50ml

9907 **Gilman**

Hand sanitizing gel in a practical 50 ml bottle. It contains 70% of alcohol.

📏 4,5 x 8,5 x 2,9 cm 📦 50 📦 200
 🗑️ C(1)

SANITIZING GEL



01 60 226 05 02

10ml

9908 **Varmus**

Hand-sanitizing gel with 70% alcohol in a practical 10 ml translucent recipient with sprayer. Cap with clip, available in different colours.

📏 12,6 x Ø1,60 cm 📦 1/50 📦 500
 🗑️ B(4)



30ml

9906 **Bishop**

Hand-sanitizing gel with 70% alcohol in a practical 30 ml recipient with carabiner.

📏 3,5 x 10 x 2,2 cm 📦 1/50 📦 200
 🗑️ C(1)



30ml

9934 **Genzel**

30 ml hand-sanitizing gel with spray.

📏 10,1 x Ø2,70 cm 📦 1/100 📦 200
 🗑️ C(1), W

ORGANIZERS



1227 Medy

Pillbox with two sections: one with two two-colour boxes and the other with a cutter to split higher-volume tablets.

9,5 x 1,6 x 4,8 cm 1/100 400

C(4), W

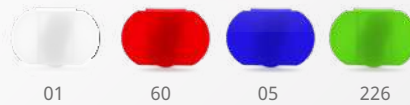

1226 Citos

Pillbox with three compartments. Design in translucent finish.

6 x 1,3 x 3,9 cm 1/100 1000

C(4), W



+ antibacterial
ISO 22196

1222 Drop

Pillbox with 3 compartments in PP with antibacterial treatment.

6 x 1,3 x 3,9 cm 1/100 1000

C(4), W

STRESS BALLS



NEW.



1232 Dona

60 05

Drop-shaped stress ball in plain colour PU.

8 x 0,5 x Ø6 cm 1/20 400

E(1)



1228 Seyku

Stress ball made of solid colour PU.

Ø6,20 cm 1/20 400

E(1)



NEW.
COLOR



1229 Biku

60 01

Heart-shaped stress ball made of solid colour PU.

7 x 7 x 4 cm 1/20 400

E(1)



55

258

02

8201 Ansar

Inflatable pillow ideal for traveling with soft suede touch.

33 x 9 x 25 cm 1/20 200

F(1)



8200 Branta

Travel mask made of soft microfiber. Double elastic adjustment.

18,5 x 9 cm 1/100 1000

D(1), N(8)



01

POUCH INCLUDED

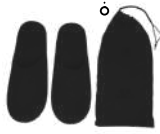

02



8151 Yllier

Unisex hotel slippers in comfortable cotton/polyester with padded lining. Practical non-woven pouch included. One size (36 to 43).

11,5 x 29 x 1,7 cm 1/10 200

E(1), N(8)

TIME TO RELAX

NEW.



03

60

40

05

226

8199 Noys

Earplugs in EVA foam. Presentation in a case with carry chain.

6,4 x Ø2,20 cm 1/200 1000

C(1)



02 55 05 60 226

7182 Oblak

Shoe bag in 600D polyester.
Practical carry handle included.

35 x 15 x 16 cm 1/25 100

F(1), N(8), O

NEW.



9935 Arnold

Resealable travel bag in transparent PVC. Assortment of practical bottles for gel, shampoo and perfume included.

19 x 19 cm 1 100

F(1)

NEW.

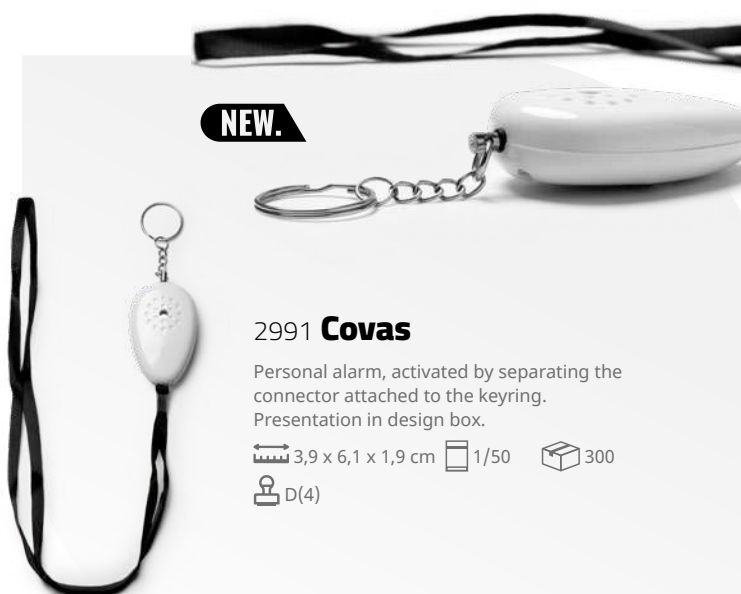

2991 Covas

Personal alarm, activated by separating the connector attached to the keyring. Presentation in design box.

3,9 x 6,1 x 1,9 cm 1/50 300

D(4)



01 03 31 60 40 05 226

7511 Caribu

Toilet bag in transparent PVC with air-tight seal.

17 x 13 x 5 cm 1/50 400

F(1)

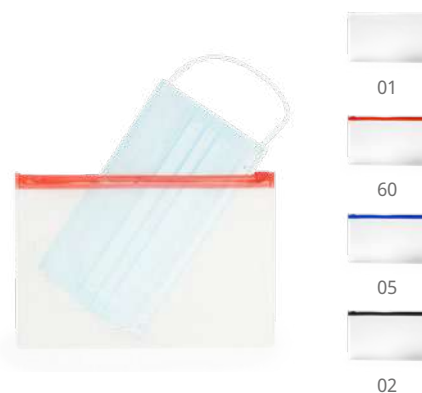

01
60
05
02

9939 Strickland

All-purpose PVC case with transparent body and colour air-tight seal fastener. Perfect to carry all types of face masks.

20 x 12,5 x 0,25 cm 20 1000

E(1)



7497 **Naro**

Multifunctional toilet bag in 100% Fairtrade cotton (180 gsm). Main pocket with matching zip and puller.

21 x 13 x 8 cm 10 100
 F(4), N(8), O, P



7498 **Zigari**

Multifunctional toilet bag in 100% Fairtrade cotton (180 gsm). Main pocket with matching zip and puller.

23 x 17 x 6 cm 50 300
 F(4), N(8), O, P



7537 **Doel**

Multipurpose 280 gsm cotton toilet bag in a two-colour design. Zipper with matching cotton puller.

22,5 x 17 x 5,5 cm 1/50 300
 F(1), N(8)



7558 **Sierra**

Multi-purpose toilet bag made of a 180 gsm cotton and jute, with zipper and matching jute puller.

21,5 x 16 x 5 cm 10 200

F(1), N(8)



7564 **Siena**

Toilet bag in cotton and laminated jute. Zip with matching jute puller.

21 x 11 x 6 cm 1/50 200

F(1), N(8)



YUTE NATURAL



7563 **Vera**

Toilet bag in cotton and laminated jute. Zip with matching jute puller.

20 x 15 x 6 cm 1/50 200

F(1), N(8)



NEW.



01

02



05



226



60



RECYCLED
PET

7547 **Bubo**

Toilet bag with two zip compartments and matching carry strap, made from 210D RPET recycled polyester.

21 x 13 x 8 cm

1/20

100

F(1), N(8), O

RECYCLED PET

NATURAL HEMP



261



152



02



HEMP

7499 **Prado**

Multifunctional toilet bag in hemp fabric (200 gsm), with matching puller.

21 x 13 x 8 cm

1/10

100

F(1), N(8)



7514 Yubarta

Toilet bag in 600D polyester with zip and puller in matching colour.

22 x 14 x 6 cm 10 300

F(1), N(8), O



7565 Sedna

Multifunctional toilet bag in 600D polyester. Zip fastening with matching puller.

22 x 14 x 6 cm 1/20 300

F(1), N(8), O



7513 Pardela

Toilet bag in 600D polyester with zip and practical carry handle.

20 x 10 x 8 cm 1/10 200

F(1), N(8), O



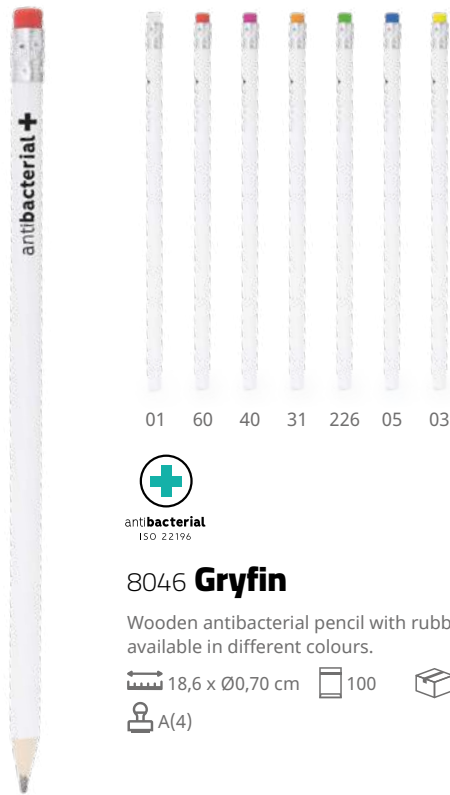

- 01
- 60
- 40
- 31
- 226
- 05
- 03



8046 **Gryfin**

Wooden antibacterial pencil with rubber available in different colours.

18,6 x Ø0,70 cm 100 2000
 A(4)



- 01
- 60
- 05
- 02



8022 **Farber**

Antibacterial sprayer ballpen with rechargeable spray and pointer. 3 ml capacity (liquid not included). Blue ink.

16 x Ø1,50 cm 1/50 1000
 B(4)

ANTIBACTERIAL



ELION8061

WATSON8060



8060 **Watson**

A5 notepad with antibacterial PU covers. Bookmark and elastic band. 100 sheets. ISO 22196 standard compliance.

14,9 x 21 x 1,4 cm 1/25 50
 E(4)



8061 **Elion**

A6 notepad with antibacterial PU covers. Bookmark and elastic band. 80 sheets. ISO 22196 standard compliance.

9 x 14 x 1,4 cm 1/50 100
 E(4)



+ antibacterial

ISO 22196



antibacterial
ISO 22196

8040 Stark

Ballpoint pen with antibacterial ABS body and blue ink. ISO 22196 standard compliance.

13,8 x Ø1 cm 1/50 1000

A(4)



antibacterial
ISO 22196



TOUCH
PEN

8015 Hallerbos

Ballpoint pen with antibacterial ABS body and touch pointer. Metal clip and jumbo blue ink refill. ISO 22196 standard compliance.

13,9 x Ø1 cm 1/50 1000

A(4)



ANTIBACTERIAL



03 31 60 05 226 02



antibacterial
ISO 22196

8039 Carrel

Antibacterial ballpen with ABS body and soft colour grip in translucent finish. Blue ink. Manufactured according to ISO 22196: 2011 standard.

14 x Ø1,30 cm 1/50 1000

A(4)



antibacterial
ISO 22196

8038 Newton

Antibacterial ballpen made of ABS. Manufactured according to ISO 22196: 2011 standard. Blue ink.

14 x Ø1,30 cm 1/50 1000

A(4)



CHRISTMAS



4012 **Berry**

Ceramic mug in matt finish with a natural bamboo lid. 370 ml capacity. Presentation in a kraft cardboard box.

10,5 x Ø8,20 cm 1 36
F(1), L2

A TOUCH OF NATURAL INSPIRATION

CORK | GLASS | BAMBOO

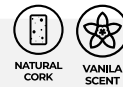

1313 **Surna**

Scented candle in a glass recipient with cork lid. Vanilla scent. Kraft cardboard card for printing included. Presentation in eco design box.

7,6 x Ø5,60 cm 1/25 100
E(1)



1315 **Vanila**

Scented candle in a translucent glass with bamboo lid. Vanilla scent. Presentation in eco design box.

8,8 x Ø7 cm 1 50
E(1), L2





CHALKBOARD



VANILLA
SCENT



1307 King

Scented candle with ceramic slate recipient. White chalk included. Presentation in a kraft cardboard box.

7,8 x Ø7,00 cm

1

50

E(1), L1

1312 Maka

Candle with a wooden recipient in two christmas designs (star and tree). Presentation in individual box.

8,7 x 2,1 x 8,4 cm

1/100

200

E(1), L1



512



511



01

03

31

60



40

05

226

02



VANILLA
SCENT

1306 Flake

Vanilla scented candle in bright colour presented to match with metallic holder. Lid with transparent window.

3 x Ø6,30 cm

1/50

250

E(1), L1



01 260 60 251 02

1311 Kimi

Scented candle in a colour glass recipient with different scents (coffee, pine, lavender, vanilla and strawberry). Presentation in individual box.

6,7 x Ø5,60 cm 1 50
F(1), L1

MAKE YOUR BRAND SHINE

PREMIUM COLOURS



251

260

**4024 Zala**

350 ml ceramic mug in a gloss finish design. Special for laser engraving. Presentation in white box.

9,6 x Ø8,20 cm 1 36
F(4), L2



1298 **Tinsel**

Wooden christmas tree with a message. Detachable stand.

11,5 x 17,7 x 3,1 cm

1/100 400

D(4), L1



512



511



510



514

1305 **Jingle**

Wooden christmas decoration, available in two designs: star and tree. Both include a red ribbon to hang on the christmas tree.

9,5 x 10 cm

1/50 400

C(4), L1



512

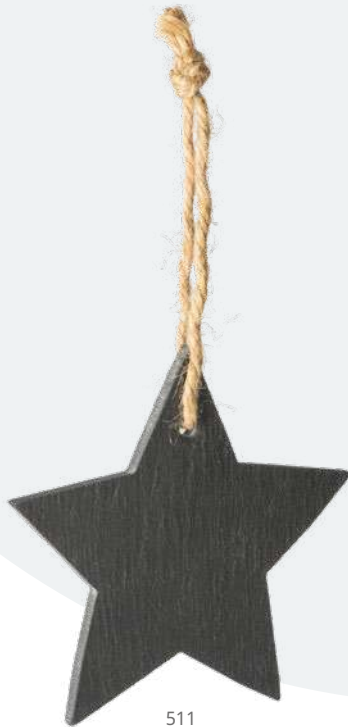

511

1299 **Rudolf**

Christmas slate ornament in two designs. Hanging strap included.

8,5 x 10 cm

1/25

100

C(1)

WELCOME CHRISTMAS



514

512

513

1302 **Abend**

Felt christmas decoration, available in three designs: snowflake, christmas tree and reindeer.

10,1 x 8,3 x 0,3 cm

10/100 500

C(1), N(8)

1310 **Carol**

3-felt christmas decoration set: star, tree and reindeer. Perfect to hang on a christmas tree.

10 x 10 cm

1/100

500

C(1)

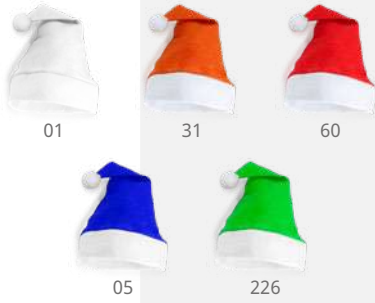

1300 **Santa**

One size christmas hat made of soft polyester.

43 x 30 cm 10 200
E(1), N(8)



FEEL LIKE
SANTA
CLAUS



1301 **Noel**

Christmas stocking with hanging strap made of soft polyester.

34 x 22 cm 10 200
E(1), N(8)



CRAYONS INCLUDED

1309 **Nick**

Children's christmas hat for colouring. Christmassy designs on the front of the white band. 4 colour crayons included.

41 x 27 cm 1/50 300
F(1), N(8)



1304 **Klaus**

Christmas magnet with Santa Claus design. Includes a notepad with 45 plain sheets and a wooden pencil.

-  20 x 10 cm
-  1/50
-  200
-  C(2)

CRAYONS INCLUDED



1308 **Reno**

Christmas stocking with 5 assorted crayons for colouring. Made of 80 gsm non-woven.

-  29,5 x 19 cm
-  1
-  200
-  F(1)



UNSHARPENED

515

516

512



1303 **Nuss**

White wooden pencil with christmas design rubber.

-  19 x 2,7 cm
-  1/50
-  500
-  B(4)

MATERIALS

MOST OF THE MATERIALS WE USE IN THE MANUFACTURE OF OUR PRODUCTS ARE NATURAL OR RECYCLED. THANKS TO THIS, IN ADDITION TO CONTRIBUTING TO THE RESPONSIBILITY OF HAVING A MORE SUSTAINABLE WORLD, THESE MATERIALS ALLOW US TO CREATE INNOVATIVE AND VERSATILE PRODUCTS, WITH A VARIETY OF FINISHES AND TEXTURES THAT ADAPT TO ALL TYPES OF SPACES.

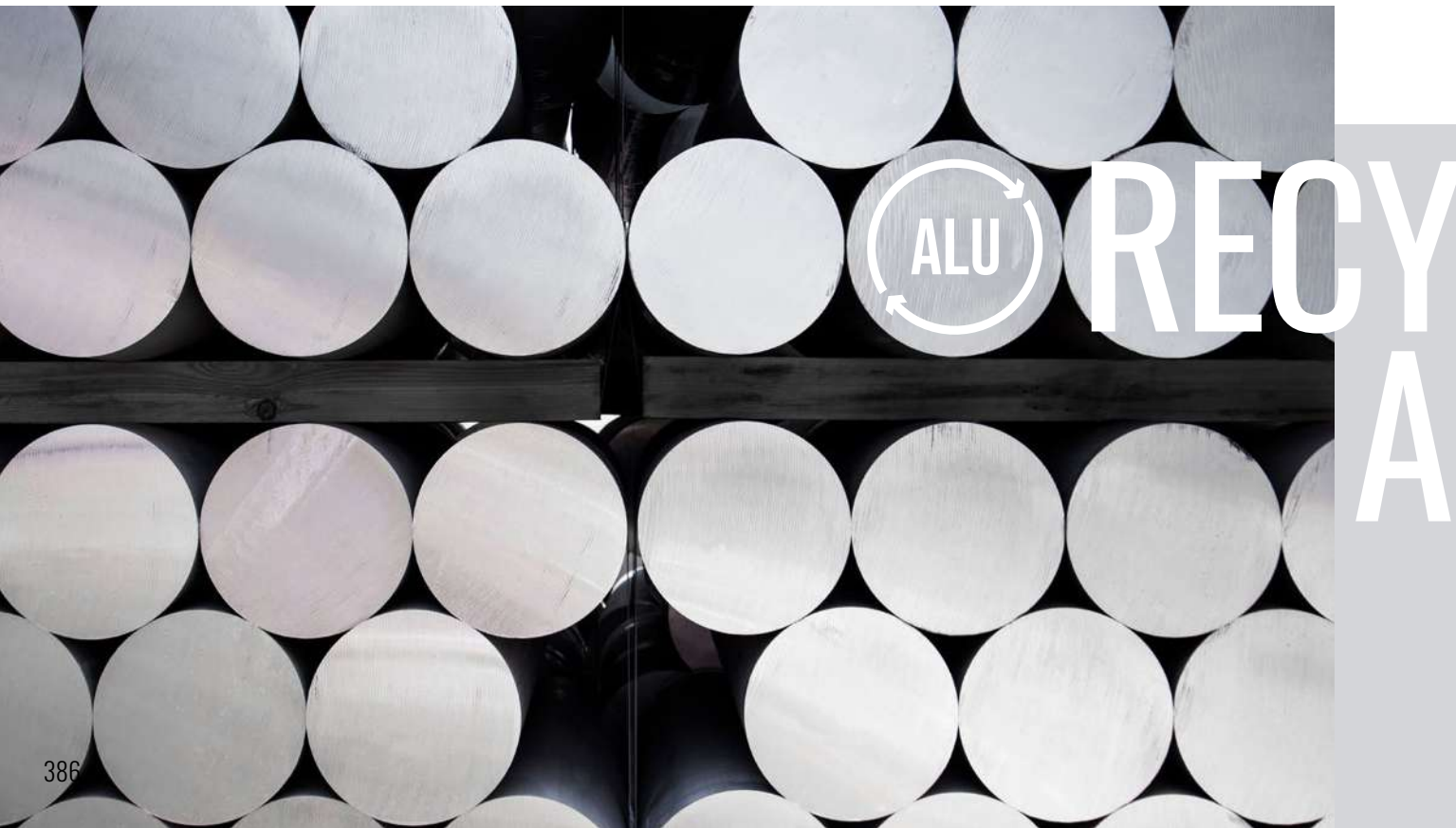

NEW MATERIAL

RECYCLED LEATHER



Leather is one of the oldest, most durable and versatile natural materials available. Thanks to its recycling, we give a new use to those leather residues originating from fashion or from the processing and treatment of the material mostly small pieces of processed leather.



NEW MATERIAL

RECYCLED ALUMINIUM

Aluminium is a highly recyclable material. It is easy to handle, light in weight, does not break, does not burn and does not rust, can be easily compacted, taking up little space. In addition, it can be 100% easily recycled without losing quality.





PLA

Also called polylactic acid, it is derived from natural and renewable raw materials, such as corn, beetroot and other starch-rich products.



LIMESTONE CEMENT



Limestone cement is a conglomerate formed from a mixture of calcined and subsequently ground limestone and clay. Once hardened when in contact with water, it is a very consistent and highly durable material.



NATURAL WOOD



Wood is a timeless and immortal material that fits perfectly with any decorative style, bringing a distinctive touch to the space in which it is placed. In addition to advantages such as strength and durability, natural wood in the home brings a good amount of benefits, including some that act directly on health.



WHEAT FIBER



Wheat fibre is an agro-industrial residue produced during the extraction of cereal grains. Originally used for livestock feed or as fodder, in recent years it has begun to be used as a bioplastic derived from plant origin, helping to reduce the consumption of plastic.





NATURAL JUTE



Known as the 'golden fibre', jute is one of the most widely used natural fibers for various textile applications since ancient times. It is a very strong and durable fibre, with insulating and antistatic properties. It is 100% biodegradable and recyclable and therefore environmentally friendly.

CORK



Cork is an environmentally friendly, biodegradable, recyclable and sustainable material. It is obtained from the bark of the cork oak, which is regenerated every year. It is highly valued for its lightness and strength. It is also a very good insulator. For example, in the form of a yoga mat it blocks the cold that rises from a cold floor. Added to this is its elegant and natural aesthetic.



BAMBOO



Bamboo is a natural, ecological and sustainable material. Due to the rapid growth of the plant, it is a very renewable material. Its advantages are multiple and it is a good alternative to the use of wood. It is known as "Plant Steel" for its resistance to certain stresses and its good seismic behaviour. It is also a very flexible and a lightweight material.

RECYCLED PET



Recycled pet or rPET, is the most recycled material in the world, helping to reduce plastics with which pet bottles are manufactured and offering a new life to their waste. It stands out for being resistant and acting effectively as a protection and barrier against water vapour and oxygen.



BAMBOO FIBER



Bamboo fibre is a natural fibre that is obtained from the filaments of the plant. Its use as an additive in different compounds results in aesthetically attractive products that provide a touch of naturalness.



RECYCLED PAPER

Recycled paper provides a second life to this cellulose fiber mainly from the wood of the trees. In addition, the production of paper from this recycled material and not from cellulose can reduce energy costs by up to 60%.





RECYCLED ABS

Recycled ABS or R-ABS is a tough, durable plastic that does not corrode easily when it comes into contact with abrasive materials. It is the result obtained after the recycling process of the ABS material, helping it not to be wasted and discarded after a single use.



ANTIBACTERIAL

Material treated with silver ions, which prevents the proliferation of pathogenic microorganisms.



TRITAN

Tritan is a new generation of recyclable and health-safe copolyester resins. This material is free from BPA, bps and any other type of bisphenol.





RECYCLED COTTON

Recycled cotton is obtained from used clothing or garment remnants. Its production reduces the amount of energy, water and dyes required. Therefore, it is one of the most sustainable and most respectful fabrics in all its processes.





ORGANIC COTTON

Organic cotton is a cotton that is produced and certified according to organic agricultural standards. It is soft, comfortable, and hypoallergenic. This fabric has the same quality as natural cotton and its cultivation creates a minimum impact on the environment.





NEW MATERIAL



FAIRTRADE COTTON

The products made with certified fair trade cotton guarantees the support of cotton growers so that they improve their quality of life and their communities, contributing to protect people and the environment.





NEW MATERIAL



HEMP

Hemp is considered the most resistant, soft, and durable textile fibre of vegetable origin. Its fabric is one of the oldest and most ecological, it is made from fibers that are extracted from the inside of the stem of the cannabis plant, which is of plant origin and biodegradable. Its great flexibility makes it ideal for making garments and accessories.





